

过渡接头

ADAPTER

GB / JB / QB Thread Fitting

国标、部标、企标接头

日标公制螺纹60°
锥面密封KES
JIS metric
thread 60°
cone flared
tube

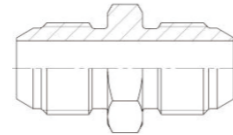

1K p.54

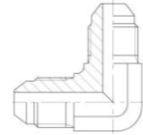

1K9 p.54

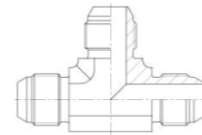

AK p.54

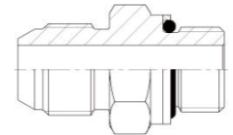

1KG p.55

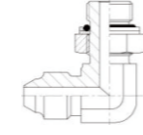

1KG9-OG p.55

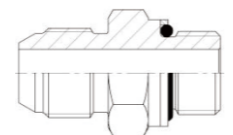

1KH p.55

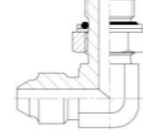

1KH9-OG p.56

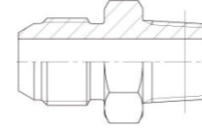

1KT p.56

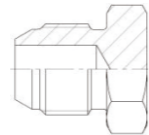

4K p.56

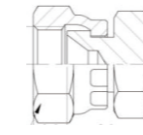

9K p.54

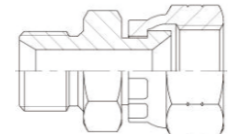

2BJ p.70

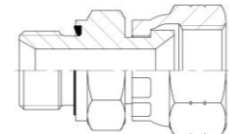

2BJ-WD p.70

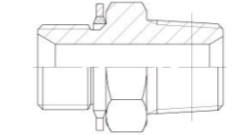

1BN p.71

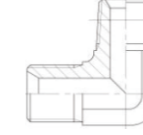

1BN9 p.71

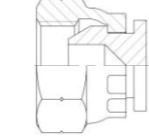

9B p.68

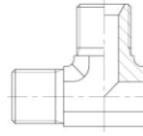

AB p.72

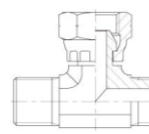

BB p.72

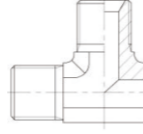

CB p.72

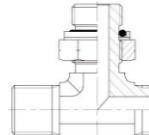

ABGB-OG p.73

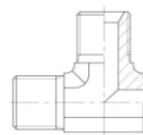

ABBG-OG p.73

BSP / BSPT Thread Fitting

英制接头

英管螺纹60°锥面
密封接头
BSP Thread 60°
cone

BSP / BSPT Thread Fitting

英制接头

日标英制螺纹60°
锥面密封接头
JIS BSP Thread
60° cone

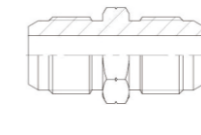

1S p.57

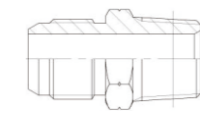

1ST p.57

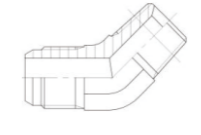

1ST4 p.57

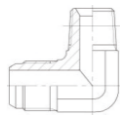

1ST9 p.58

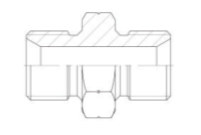

1B p.58

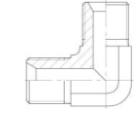

1B9 p.59

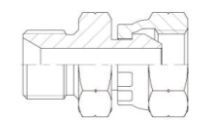

2B p.59

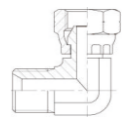

2B9 p.59

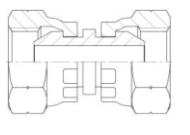

3B p.60

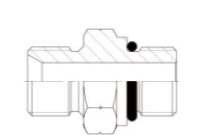

1BG p.60

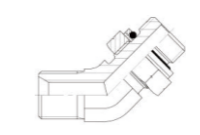

1BG4 p.60

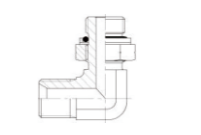

1BG9-OG p.61

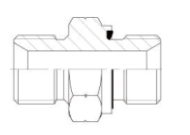

1B-WD p.62

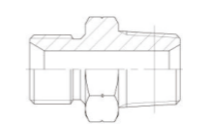

1BT p.61

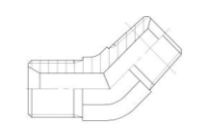

1BT4 p.62

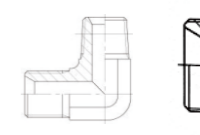

1BT9 p.63

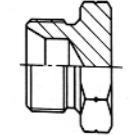

4B p.63

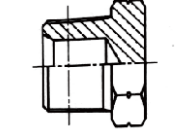

4T p.64

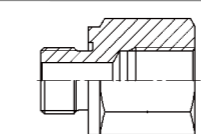

5B-WD p.65

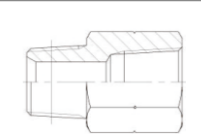

5T p.66



7T p.67

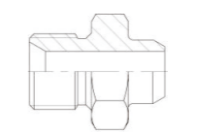

1BW p.65

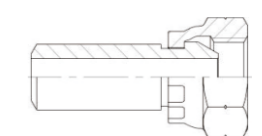

2WB p.66

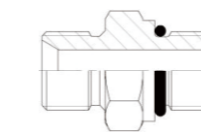

1BO p.68

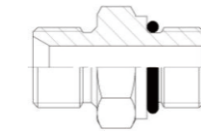

1BH p.67

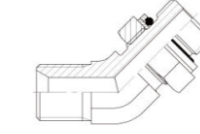

1BH4-OG p.69

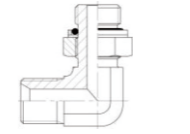

1BH9-OG p.69

美制接头
JIC · ORFS · SAE · NPT and NPSM Thread

美制螺纹平面
O形圈密封接头
ORFS Thread

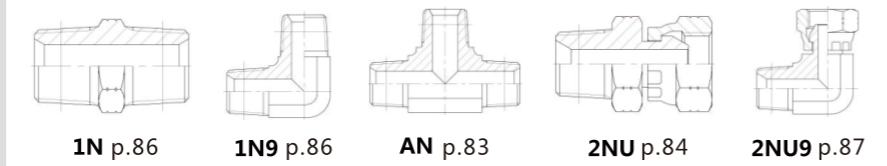
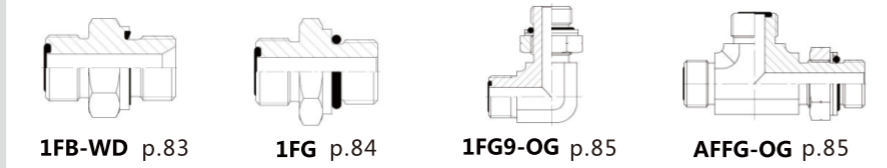
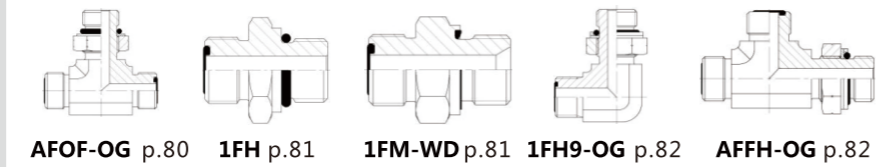
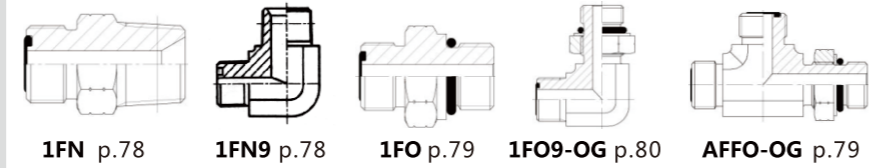
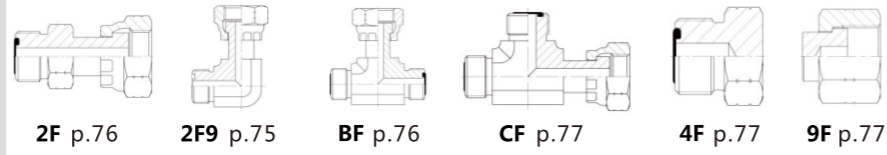
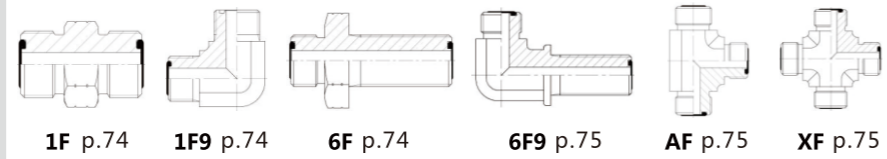

美制管螺纹接头
NPT、NPSM
Thread

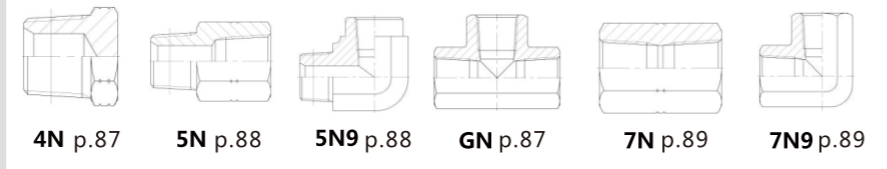

美制接头
JIC · ORFS · SAE · NPT and NPSM Thread

美制螺纹74°
锥面密封接头
JIC 74° cone

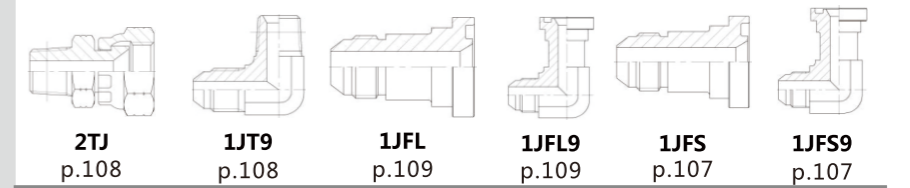
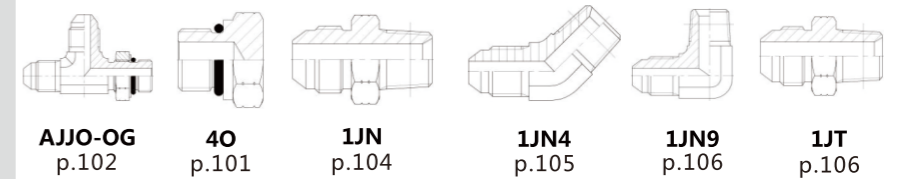
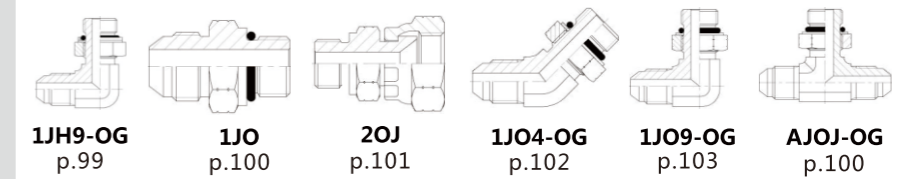
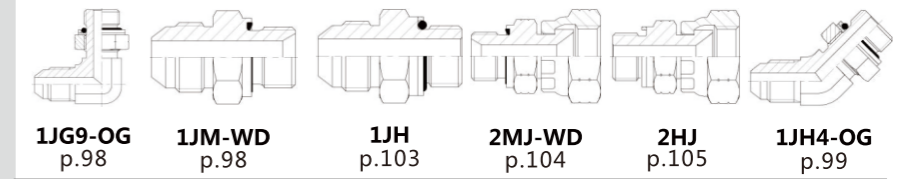
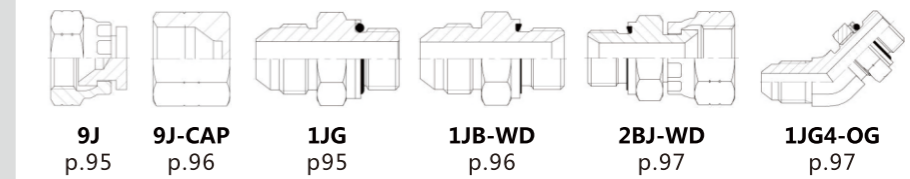
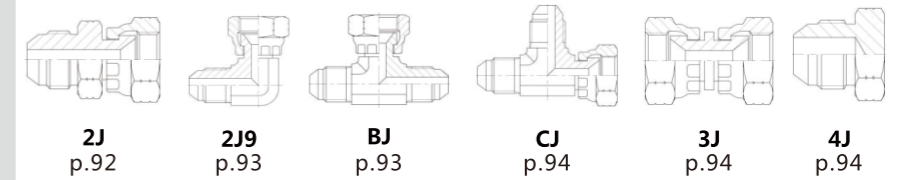
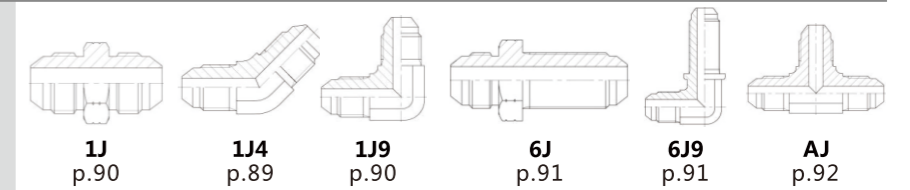

一直过渡接头代号 Straight part NO.

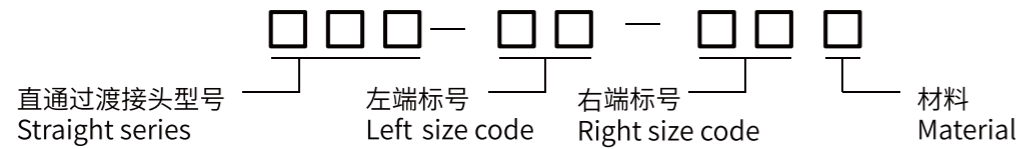

| 第一位数字 | 第二或第三位字母 |
|------------------------------------|-------------------------|
| 1 外螺纹/外螺纹 Male / Male | A 英管螺纹球面 |
| | B 英管螺纹60°锥面BSPP |
| 2 外螺纹/活动内螺纹 Male/ Female | C 公制24°轻系列 |
| | D 公制24°重系列 |
| 3 活动内螺纹 / 活动内螺纹 Female / Female | E 公制平面带O形圈 |
| | F 美制ORFS平面 |
| 4 外螺纹堵头 Plug | G 英管螺纹平面、O-Ring 密封 |
| | H 公制六角端面O-Ring 密封 |
| 5 外螺纹/ 固定内螺纹 Male / | I 铰接式 |
| | J 美制JIC 74° |
| 6 过板接头 | K 公制外螺纹60°外锥或公制内螺纹60°内锥 |
| | L 公制组合垫密封 |
| 7 固定内螺纹/固定内螺纹 | M 公制60°锥面或六角端面组合垫密封 |
| | N 美制布锥管 |
| 8 锁母 | O 美制SAE O-Ring BOSS |
| | P 美制SAE90° |
| 9 内螺纹堵头 | Q 公制74° |
| | S 英管外螺纹60°外锥或英管内螺纹60°内锥 |
| | T 英锥管螺纹 BSPT |
| | U NPSM |
| | W 焊接管 |
| | Y 煤矿接头 |
| | FL SAE法兰轻系列61型 |
| | FS SAE法兰重系列62型 |
| | FG 泵吸口法兰 |
| | FY 三角焊接法兰 |

2. 标号根据螺纹或尺寸大小来确定, 具体按下表所示。 Size code table:

| 英管螺纹 BSPThread | G1/8" X28 | G1/4" X19 | — | G3/8" X19 | G1/2" X14 | G5/8" X14 | G3/4" X14 | G1"X11 | G1.1/4" X11 | G1.1/2" X11 | G2"X11 |
|--------------------------------|--------------|---------------------|-------------------|----------------------|----------------------|--------------------|----------------------|----------------------|-----------------------|---------------------|---------------------|
| 英锥管螺纹 BSPT Thread | R1/8" X28 | R1/4" X19 | — | R3/8" X19 | R1/2" X14 | — | R3/4" X14 | R1"X11 | R1.1/4" X11 | R1.1/2" X11 | R2"X11 |
| 布锥管螺纹 NPT Thread | Z1/8" X27 | Z1/4" X18 | | Z3/8" X18 | Z1/2" X14 | — | Z3/4" X14 | Z1"X11.5 | Z1.1/4" X11.5 | Z1.1/2" X11.5 | Z2"X11.5 |
| 美制JIC螺纹 JIC Thread | — | 7/16" X20 UNF | 1/2 X20 UNF | 9/16" X18 UNF | 3/4" X16 UNF | 7/8" X14 UNF | 1.1/16" X12 UN | 1.5/16" X12 UN | 1.5/8" X12 UN | 1.7/8" X12 UN | 2.1/2" X12 UN |
| 美制ORFS螺 纹 ORFS Thread | — | 9/16" X20 UNF | — | 11/16" X16 UNF | 13/16" X16 UNF | 1"X14 UNF | 1.3/16" X12 UN | 1.7/16" X12 UN | 1.11/16" X12 UN | 2"X12 UN | — |
| 美制SAE螺 纹 SAE Thread | — | — | — | 5/8" X18 UNF | — | — | 1.1/16" X12 UN | — | — | — | — |
| 法兰 Flange Size | — | — | — | — | 1/2" | 5/8" | 3/4" | 1" | 1.1/4" | 1.1/2" | 2" |
| 标号 Size Code | 02 | 04 | 05 | 06 | 08 | 10 | 12 | 16 | 20 | 24 | 32 |

注: 公制螺纹标号与螺纹大径一致。 Note: The size of metric thread accords with the O.D. of thread.

3. 当材料代号为碳钢时, 则不标注材料代号, 其他材料的代号如下表所示。
Don't need material code if the material is carbon steel, and the code for other material is defined as following:

| 材料 Material | 碳钢 Carbon steel | 铜 Brass | 不锈钢 Stainless steel |
|-------------|-----------------|---------|---------------------|
| 代号 Code | — | BR | SS |

标注示例: Example order:

1CG-22-08直过渡接头系列, 左端为外螺纹24°内锥轻系列, 螺纹为M22X1.5; 右端为英管螺纹平面O-Ring密封, 螺纹为G1/2"X14, 用碳钢制作的接头。

If 1CG-22-08 left end is metric male 24° cone seat L.T., thread is M22X1.5; right end is BSP thread stud ends with, thread is G1/2"X14, the carbon steel fitting.

注: Note:

1. 在原代号后加“OR”, 表示在60、74、90外锥面上加O-Ring, 如1J-08-06OR, 表示右端即-06端锥面上加O-Ring; 1J-08-06/2OR表示两端即-08端及-06端均加O-Ring。
2. 固定内螺纹/活动内螺纹的表示方法为第一位数字为7, 再在后面加“S”, 如7TC-04-16S
3. 外螺纹/活动内螺纹的表示方法为第一位数字为5, 再在后面加“S”, 如5TD-08-30S。
4. W端焊接管较短时, 在代号后加“S”, 如3BW-12S。
5. 对用于卡套式的直管, 用“W”表示, 并在后面加“P”, 如1CW-18-12P; 表示右端为直管, 用于卡套式, 不用于焊接式。
6. 焊接管的尺寸为英寸制时, 在代号后加“IN”, 如5BW-08IN。
7. 内六角外螺纹堵头在原代号中加“N”, 如4MN-22WD、4BN-08WD、4TN-08等。
8. 用CAPTIVE密封的接头型式, 在代号后加“WD”, 如1CB-22-08WD。
9. 对J端加长的过渡接头, 在代号后加“L”, 如1JO-10-08L。
10. 对可调向接头, 在代号后加“OG”, 如1CG-22-06OG。
11. 对T端接头需加工60°内锥面的接头, 在代号后加“SP”, 如1CT-18-06SP。
12. 对活动螺母为穿钢丝型式的接头, 在代号后加“W”, 如2C9-18W。
13. 24°带O-Ring锥密封接头, 如使用GB标准规格的O-Ring, 在代号后加“G”, 如2C9-28WG。

二、角弯过渡接头代号:在直通过渡接头型号后加“4”表示45°弯曲过渡接头,在直通过渡接头型号后加“9”表示90°弯曲过渡接头。如1CG9-22-06OG、2C4-22等。

Elbow part NO.:Add suffix “4” for 45° elbow and suffix “9” for 90° elbow to the straight part number .e.g, 1CG9-22-06OG and 2C4-22.

三、三通过渡接头代号 Tee part NO.



第一个字母的含义如下所示,其余字母的含义与直通过渡接头中的“第二或第三位字母”相同,标号与直通过渡接头中标号含义相同。

- A 外螺纹/外螺纹/外螺纹
- B 外螺纹/活动内螺纹/外螺纹
- C 外螺纹/外螺纹/活动内螺纹
- D 活动内螺纹/活动内螺纹/活动内螺纹
- E 活动内螺纹/外螺纹/活动内螺纹
- F 活动内螺纹/活动内螺纹/外螺纹
- G 固定内螺纹/固定内螺纹/固定内螺纹
- H 固定内螺纹/固定内螺纹/外螺纹
- J 固定内螺纹/外螺纹/固定内螺纹
- K 外螺纹/固定内螺纹/外螺纹
- L 外螺纹/外螺纹/固定内螺纹
- M 活动内螺纹/固定内螺纹/活动内螺纹
- N 外螺纹/固定内螺纹/活动内螺纹
- O 固定内螺纹/固定内螺纹/活动内螺纹
- P 固定内螺纹/外螺纹/活动内螺纹
- Q 固定内螺纹/活动内螺纹/外螺纹

标注示例: Example of order:

ACCG-22-30-08OG 三通过渡接头系列,左端为外螺纹24°内锥轻系列,螺纹为M22X1.5;中端为外螺纹24°内锥轻系列,螺纹为M30X2.0;右端为英管螺纹平面O-Ring密封,螺纹为G1/2"X14,用碳钢制作的接头。

If ACCG-22-30-08OG left end is metric male 24° cone seat L.T., thread is M22X1.5, mid end is metric male 24° cone seat L.T., thread is M30X2.0; right end is BSP thread stud ends with, thread is G1/2"X14,the carbon steel fitting .

四、四通过渡接头代号 Cross part NO.

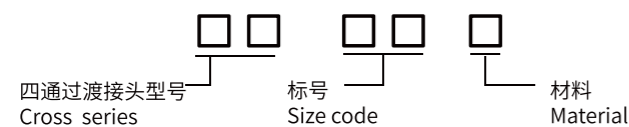

1、对四通过渡接头一般四端都相同,因此只标注一个标号,如四端不同,则第一组表示左端,第二组表示上端,第三组表示右端,第四组表示下端。

In general for cross fitting, the four ends thread is the same ,if different ,the first group means left ,the second group means up ,the third group means right and fourth group means down .

2、四通接头编号规则:

第一个字母含义如下所示,其余字母含义与直通过渡接头中“第二或第三位字母”相同。

- X 表示四端都是外螺纹
- Y 表示四端都是活动内螺纹
- Z 表示四端都是固定内螺纹
- T 表示三端为外螺纹一端为固定内螺纹
- W 表示三端为外螺纹一端为活动内螺纹
- V 表示三端为固定内螺纹一端为外螺纹
- O 表示三端为活动内螺纹一端为外螺纹

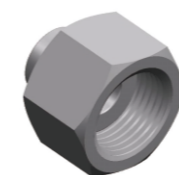
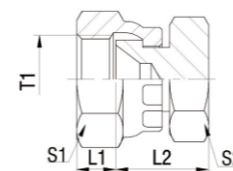
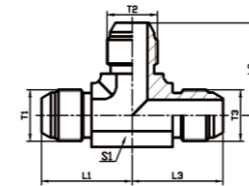
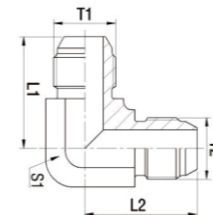
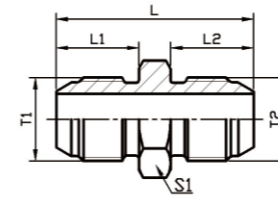

1K

日本公制外螺纹60°外锥 JIS METRIC MALE 60°CONE

| 产品代号 PART NO | 螺纹 ETHREAD | | 尺寸 DIMENSIONS | | | | 压力等级 MPa |
|-----------------|------------|---------|---------------|------|----|----|-------------|
| | T1 | T2 | L1 | L2 | L | S1 | |
| 1K-14 | M14X1.5 | M14X1.5 | 17 | 17 | 40 | 17 | 34.5 |
| 1K-16 | M16X1.5 | M16X1.5 | 18 | 18 | 42 | 17 | |
| 1K-18 | M18X1.5 | M18X1.5 | 18 | 18 | 42 | 19 | |
| 1K-20 | M20X1.5 | M20X1.5 | 20 | 20 | 48 | 22 | |
| 1K-22 | M22X1.5 | M22X1.5 | 20 | 20 | 48 | 24 | |
| 1K-24 | M24X1.5 | M24X1.5 | 21.5 | 21.5 | 53 | 27 | |
| 1K-30 | M30X1.5 | M30X1.5 | 26 | 26 | 63 | 32 | 20.5 |
| 1K-33 | M33X1.5 | M33X1.5 | 30 | 30 | 71 | 36 | |
| 1K-36 | M36X1.5 | M36X1.5 | 33 | 33 | 79 | 41 | |
| 1K-42 | M42X1.5 | M42X1.5 | 36 | 36 | 85 | 46 | 17 |

1K9

90°日本公制外螺纹60°外锥 90°JIS METRIC MALE 60°CONE

| 产品代号 PART NO. | 螺纹 ETHREAD | | 尺寸 DIMENSIONS | | | | 压力等级 MPa |
|------------------|------------|---------|---------------|------|--|----|-------------|
| | T1 | T2 | L1 | L2 | | S1 | |
| 1K9-14 | M14X1.5 | M14X1.5 | 26.5 | 26.5 | | 14 | 34.5 |
| 1K9-16 | M16X1.5 | M16X1.5 | 29.5 | 29.5 | | 16 | |
| 1K9-18 | M18X1.5 | M18X1.5 | 30.8 | 30.8 | | 19 | |
| 1K9-22 | M22X1.5 | M22X1.5 | 35.5 | 35.5 | | 22 | |
| 1K9-24 | M24X1.5 | M24X1.5 | 37 | 37 | | 22 | |
| 1K9-30 | M30X1.5 | M30X1.5 | 45 | 45 | | 30 | |
| 1K9-33 | M33X1.5 | M33X1.5 | 50 | 50 | | 33 | |
| 1K9-36 | M36X1.5 | M36X1.5 | 57 | 57 | | 41 | |
| 1K9-42 | M42X1.5 | M42X1.5 | 63 | 63 | | 41 | 17 |

AK

日本公制外螺纹60°外锥三通 JIS METRIC MALE 60°CONE TEE

| 产品代号 PART NO. | 螺纹 ETHREAD | | | 尺寸 DIMENSIONS | | | | 压力等级 MPa |
|------------------|------------|---------|---------|---------------|------|------|----|-------------|
| | T1 | T2 | T3 | L1 | L2 | L3 | S1 | |
| AK-14 | M14X1.5 | M14X1.5 | M14X1.5 | 26.5 | 26.5 | 26.5 | 14 | 34.5 |
| AK-16 | M16X1.5 | M16X1.5 | M16X1.5 | 29.5 | 29.5 | 29.5 | 16 | |
| AK-18 | M18X1.5 | M18X1.5 | M18X1.5 | 30.8 | 30.8 | 30.8 | 19 | |
| AK-22 | M22X1.5 | M22X1.5 | M22X1.5 | 35.5 | 35.5 | 35.5 | 22 | |
| AK-24 | M24X1.5 | M24X1.5 | M24X1.5 | 37 | 37 | 37 | 22 | 27.5 |
| AK-30 | M30X1.5 | M30X1.5 | M30X1.5 | 45 | 45 | 45 | 30 | |
| AK-33 | M33X1.5 | M33X1.5 | M33X1.5 | 50 | 50 | 50 | 33 | |

9K

日本公制外内螺纹60°内锥堵头 JIS METRIC FEMALE 60°CONE PLUG

| 产品代号 PART NO. | 螺 纹 T1 THREAD T1 | 尺寸 DIMENSIONS | | | | 压力等级MPa |
|------------------|---------------------|---------------|------|----|----|---------|
| | | A | L1 | S1 | S2 | |
| 9K-14 | M14X1.5 | 10.5 | 15 | 19 | 19 | 34.5 |
| 9K-16 | M16X1.5 | 10 | 17.5 | 22 | 22 | |
| 9K-18 | M18X1.5 | 11.5 | 18.5 | 24 | 24 | |
| 9K-22 | M22X1.5 | 14 | 21 | 27 | 27 | |
| 9K-24 | M24X1.5 | 15 | 22.5 | 32 | 32 | 27.5 |
| 9K-30 | M30X1.5 | 18.3 | 25 | 36 | 36 | |
| 9K-33 | M33X1.5 | 21.3 | 25.5 | 41 | 41 | |

1KG

日本公制外螺纹60°外锥/英管外螺纹O型圈 JIS METRIC MALE 60°CONE/B MALE O-RING

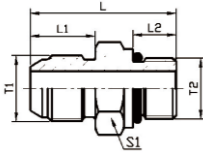

| 产品代号 PART NO. | 螺纹 ETHREAD | | 尺寸 DIMENSIONS | | | | 压力等级 MPa |
|------------------|------------|----------|---------------|------|------|----|-------------|
| | T1 | T2 | L1 | L2 | L | S1 | |
| 1KG-14-04 | M14X1.5 | G1/4"X19 | 17 | 11 | 36 | 19 | 31.5 |
| 1KG-14-06 | M14X1.5 | G3/8"X19 | 17 | 11.5 | 36.5 | 22 | |
| 1KG-16-06 | M16X1.5 | G3/8"X19 | 18 | 11.5 | 38 | 22 | |
| 1KG-18-06 | M18X1.5 | G3/8"X19 | 18 | 11.5 | 38 | 22 | |
| 1KG-22-08 | M22X1.5 | G1/2"X14 | 20 | 14 | 47 | 27 | |
| 1KG-30-12 | M30X1.5 | G3/4"X14 | 26 | 15.5 | 52.5 | 32 | 20 |
| 1KG-33-12 | M33X1.5 | G3/4"X14 | 30 | 15.5 | 59.5 | 36 | |
| 1KG-33-16 | M33X1.5 | G1" X11 | 30 | 18 | 62 | 41 | |

1KG9-OG

日本公制外螺纹60°外锥/英管外螺纹O型圈可调向柱端
JIS METRIC MALE 60°CONE/B MALE O-RING ADJUSTABLE STUD END

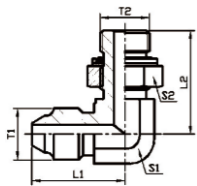

| 产品代号 PART NO. | 螺纹 ETHREAD | | 尺寸 DIMENSIONS | | | 压力等级 MPa |
|------------------|------------|-------------|---------------|------|----|-------------|
| | T1 | T2 | L1 | L2 | S1 | |
| 1KG9-14-04OG | M14X1.5 | G1/4"X19 | 26.5 | 31.3 | 14 | 31.5 |
| 1KG9-14-06OG | M14X1.5 | G3/8"X19 | 27.5 | 35.8 | 16 | |
| 1KG9-16-06OG | M16X1.5 | G3/8"X19 | 29.5 | 35.8 | 16 | |
| 1KG9-18-06OG | M18X1.5 | G3/8"X19 | 30.8 | 37 | 19 | |
| 1KG9-22-08OG | M22X1.5 | G1/2"X14 | 35.5 | 43.2 | 22 | |
| 1KG9-24-08OG | M24X1.5 | G1/2"X14 | 37 | 46 | 24 | 16 |
| 1KG9-24-12OG | M24X1.5 | G3/4"X14 | 40 | 49.3 | 27 | |
| 1KG9-30-12OG | M30X1.5 | G3/4"X14 | 45 | 53 | 30 | |
| 1KG9-33-16OG | M33X1.5 | G1" X11 | 50 | 53 | 33 | |
| 1KG9-42-20OG | M42X1.5 | G1.1/4" X11 | 63 | 59 | 41 | |

1KH

日本公制外螺纹60°外锥/公制外螺纹重系列ISO 6149-2
JIS METRIC MALE 60°CONE/METIRC MALE S-SERIES ISO 6149-2

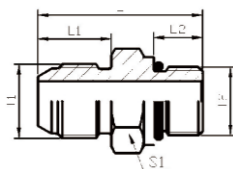

| 产品代号 PART NO. | 螺纹 ETHREAD | | 尺寸 DIMENSIONS | | | | 压力等级 MPa |
|------------------|------------|---------|---------------|------|------|----|-------------|
| | T1 | T2 | L1 | L2 | L | S1 | |
| 1KH-14-12 | M14X1.5 | M12X1.5 | 17 | 11 | 39 | 17 | 34.5 |
| 1KH-14 | M14X1.5 | M14X1.5 | 17 | 11 | 39 | 19 | |
| 1KH-16-14 | M16X1.5 | M14X1.5 | 18 | 11 | 40 | 19 | |
| 1KH-18-14 | M18X1.5 | M14X1.5 | 18 | 11 | 40 | 19 | |
| 1KH-18-16 | M18X1.5 | M16X1.5 | 18 | 12.5 | 42 | 22 | |
| 1KH-18-20 | M18X1.5 | M20X1.5 | 18 | 14 | 45 | 22 | |
| 1KH-20-18 | M20X1.5 | M18X1.5 | 20 | 14 | 47 | 22 | |
| 1KH-22-20 | M22X1.5 | M20X1.5 | 20 | 14 | 47 | 22 | |
| 1KH-24-20 | M24X1.5 | M20X1.5 | 21.5 | 14 | 48.5 | 22 | |
| 1KH-24-22 | M24X1.5 | M22X1.5 | 21.5 | 15 | 50 | 22 | |
| 1KH-30-27 | M30X1.5 | M27X2 | 26 | 18.5 | 60.5 | 22 | 20.5 |
| 1KH-33 | M33X1.5 | M33X2 | 30 | 18.5 | 65 | 22 | |
| 1KH-36-33 | M36X1.5 | M33X2 | 33 | 18.5 | 68 | 22 | 17 |

1KH9-OG

90°日本公制外螺纹60°外锥/公制外螺纹可调向柱端重系列ISO 6149-2
90°JIS METRIC MALE 60°CONE / METIRC MALE ADJUSTABLE STUD END S-SERIES ISO 6149-2

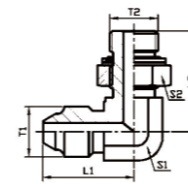

| 产品代号 PART NO. | 螺纹 ETHREAD | | 尺寸 DIMENSIONS | | | 压力等级 MPa | |
|------------------|------------|---------|---------------|------|----|-------------|------|
| | T1 | T2 | L1 | L2 | S1 | | |
| 1KH9-14-12OG | M14X1.5 | M12X1.5 | 26.5 | 33.5 | 14 | 34.5 | |
| 1KH9-14OG | M14X1.5 | M14X1.5 | 26.5 | 34.5 | 14 | | |
| 1KH9-16-14OG | M16X1.5 | M14X1.5 | 29.5 | 35.5 | 16 | | |
| 1KH9-18-14OG | M18X1.5 | M14X1.5 | 30.8 | 37.5 | 19 | | |
| 1KH9-18-16OG | M18X1.5 | M16X1.5 | 30.8 | 39.5 | 19 | | |
| 1KH9-18-20OG | M18X1.5 | M20X1.5 | 30.8 | 44 | 19 | | |
| 1KH9-20-18OG | M20X1.5 | M18X1.5 | 33 | 42.5 | 19 | | |
| 1KH9-22-20OG | M22X1.5 | M20X1.5 | 35.5 | 45.5 | 22 | | |
| 1KH9-24-20OG | M24X1.5 | M20X1.5 | 37 | 47 | 27 | | 27.5 |
| 1KH9-24-22OG | M24X1.5 | M22X1.5 | 37 | 47 | 27 | | |
| 1KH9-30-27OG | M30X1.5 | M27X2 | 45 | 57 | 30 | 20.5 | |
| 1KH9-33OG | M33X1.5 | M33X2 | 50 | 59 | 33 | | |
| 1KH9-36-33OG | M36X1.5 | M33X2 | 57 | 60.5 | 36 | | |

1KT

日本公制外螺纹60°外锥/英锥管外螺纹
JIS METRIC MALE 60°CONE/BT MALE

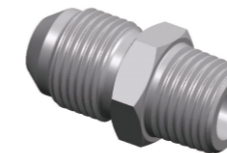
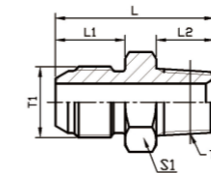

| 产品代号 PART NO. | 螺纹 ETHREAD | | 尺寸 DIMENSIONS | | | | 压力等级 MPa | |
|------------------|------------|-------------|---------------|------|------|----|-------------|------|
| | T1 | T2 | L1 | L2 | L | S1 | | |
| 1KT-14-04 | M14X1.5 | R1/4" X29 | 17 | 14.5 | 37.5 | 17 | 34.5 | |
| 1KT-14-06 | M14X1.5 | R3/8" X19 | 17 | 15 | 38 | 19 | | |
| 1KT-16-06 | M16X1.5 | R3/8" X19 | 18 | 15 | 39 | 19 | | |
| 1KT-18-06 | M18X1.5 | R3/8" X19 | 18 | 15 | 39 | 19 | | |
| 1KT-20-06 | M20X1.5 | R3/8" X19 | 20 | 15 | 43 | 22 | | |
| 1KT-22-06 | M22X1.5 | R3/8" X19 | 20 | 15 | 43 | 24 | | |
| 1KT-22-08 | M22X1.5 | R1/2" X14 | 20 | 20 | 48 | 24 | | |
| 1KT-24-08 | M24X1.5 | R1/2" X14 | 21.5 | 20 | 51.5 | 27 | | 27.5 |
| 1KT-24-12 | M24X1.5 | R3/4" X14 | 21.5 | 20 | 51.5 | 30 | | |
| 1KT-30-12 | M30X1.5 | R3/4" X14 | 26 | 20 | 57 | 32 | | 20.5 |
| 1KT-33-16 | M33X1.5 | R1" X11 | 30 | 25.5 | 66.5 | 36 | | |
| 1KT-36-20 | M36X1.5 | R1.1/4" X11 | 33 | 26.5 | 72.5 | 46 | 17 | |
| 1KT-42-24 | M42X1.5 | R1.1/2" X11 | 36 | 26.5 | 77.5 | 50 | 10.5 | |

4K

日本公制外螺纹60°外锥堵头
JIS METRIC MALE 60°CONE PLUG

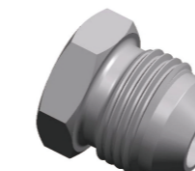
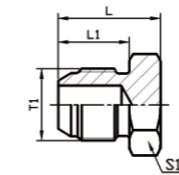

| 产品代号 PART NO. | 螺纹 ETHREAD | 尺寸 DIMENSIONS | | | 压力等级 MPa |
|------------------|------------|---------------|------|----|-------------|
| | | L1 | L | S1 | |
| 4K-14 | M14X1.5 | 17 | 23 | 17 | 34.5 |
| 4K-16 | M16X1.5 | 18 | 24 | 17 | |
| 4K-18 | M18X1.5 | 18 | 25 | 19 | |
| 4K-20 | M20X1.5 | 20 | 28 | 22 | |
| 4K-22 | M22X1.5 | 20 | 28 | 24 | |
| 4K-24 | M24X1.5 | 21.5 | 31.5 | 27 | |
| 4K-30 | M30X1.5 | 26 | 37 | 32 | 20.5 |
| 4K-33 | M33X1.5 | 30 | 41 | 36 | |

1S

日本英管外螺纹60°外锥
JIS GAS MALE 60° CONE

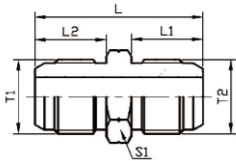

| 产品代号 PART NO. | 螺纹 THREAD | | 尺寸 DIMENSIONS | | | |
|------------------|------------|------------|---------------|----|----|----|
| | T1 | T2 | L1 | L2 | L | S1 |
| 1S-02 | G1/8"X28 | G1/8"X28 | 12 | 12 | 30 | 14 |
| 1S-04 | G1/4"X19 | G1/4"X19 | 16 | 16 | 38 | 17 |
| 1S-06 | G3/8"X19 | G3/8"X19 | 18 | 18 | 42 | 19 |
| 1S-08 | G1/2"X14 | G1/2"X14 | 20 | 20 | 48 | 22 |
| 1S-12 | G3/4"X14 | G3/4"X14 | 22 | 22 | 54 | 30 |
| 1S-16 | G1"X11 | G1"X11 | 24 | 24 | 59 | 36 |
| 1S-20 | G1.1/4"X11 | G1.1/4"X11 | 27 | 27 | 67 | 46 |
| 1S-24 | G1.1/2"X11 | G1.1/2"X11 | 27 | 27 | 69 | 50 |
| 1S-32 | G2"X11 | G2"X11 | 30 | 30 | 77 | 65 |

1ST

日本英管外螺纹60°内外锥/英锥管外螺纹
JIS GAS MALE 60° CONE/BSPT MALE

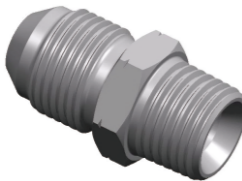
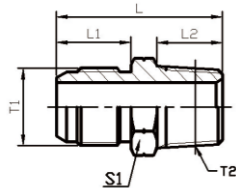

| 产品代号 PART NO. | 螺纹 THREAD | | 尺寸 DIMENSIONS | | | |
|------------------|------------|------------|---------------|------|------|----|
| | T1 | T2 | L1 | L2 | L | S1 |
| 1ST-02 | G1/8"X28 | R1/8"X28 | 12 | 10 | 28 | 14 |
| 1ST-04 | G1/4"X19 | R1/4"X19 | 16 | 14.5 | 36.5 | 17 |
| 1ST-06 | G3/8"X19 | R3/8"X19 | 18 | 15 | 39 | 19 |
| 1ST-08 | G1/2"X14 | R1/2"X14 | 20 | 20 | 48 | 24 |
| 1ST-12 | G3/4"X14 | R3/4"X14 | 22 | 20 | 52 | 30 |
| 1ST-16 | G1"X11 | R1"X11 | 24 | 25.5 | 60.5 | 36 |
| 1ST-20 | G1.1/4"X11 | R1.1/4"X11 | 27 | 26.5 | 66.5 | 46 |
| 1ST-24 | G1.1/2"X11 | R1.1/2"X11 | 27 | 26.5 | 68.5 | 50 |
| 1ST-32 | G2"X11 | R2"X11 | 30 | 30 | 77 | 65 |

1ST4

45°日本英管外螺纹60°外锥/英锥管外螺纹
45°JIS GAS MALE 60° CONE/BSPT MALE

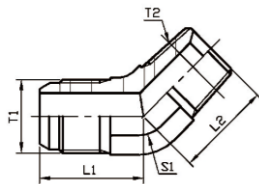

| 产品代号 PART NO. | 螺纹 THREAD | | 尺寸 DIMENSIONS | | |
|------------------|------------|------------|---------------|----|----|
| | T1 | T2 | L1 | L2 | S1 |
| 1ST4-02 | G1/8"X28 | R1/8"X28 | 19 | 17 | 11 |
| 1ST4-04 | G1/4"X19 | R1/4"X19 | 21.8 | 20 | 14 |
| 1ST4-06 | G3/8"X19 | R3/8"X19 | 24 | 22 | 16 |
| 1ST4-08 | G1/2"X14 | R1/2"X14 | 29.5 | 27 | 22 |
| 1ST4-12 | G3/4"X14 | R3/4"X14 | 32.8 | 30 | 27 |
| 1ST4-16 | G1"X11 | R1"X11 | 37 | 38 | 33 |
| 1ST4-20 | G1.1/4"X11 | R1.1/4"X11 | 43.5 | 40 | 41 |
| 1ST4-24 | G1.1/2"X11 | R1.1/2"X11 | 44.5 | 41 | 50 |
| 1ST4-32 | G2"X11 | R2"X11 | 51 | 50 | 63 |

1ST9

90°日本英管外螺纹60°外锥/英锥管外螺纹
90°JIS GAS MALE 60° CONE/BSPT MALE

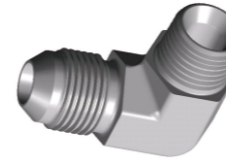
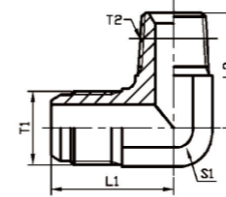

| 产品代号 PART NO. | 螺纹 THREAD | | 尺寸 DIMENSIONS | | |
|------------------|------------|------------|---------------|------|----|
| | T1 | T2 | L1 | L2 | S1 |
| 1ST9-02 | G1/8"X28 | R1/8"X28 | 21.8 | 21 | 11 |
| 1ST9-04 | G1/4"X19 | R1/4"X19 | 26.3 | 25.5 | 14 |
| 1ST9-06 | G3/8"X19 | R3/8"X19 | 30 | 28.5 | 16 |
| 1ST9-08 | G1/2"X14 | R1/2"X14 | 37 | 35 | 22 |
| 1ST9-12 | G3/4"X14 | R3/4"X14 | 41.5 | 43.5 | 27 |
| 1ST9-16 | G1"X11 | R1"X11 | 47.5 | 50 | 33 |
| 1ST9-20 | G1.1/4"X11 | R1.1/4"X11 | 57 | 56.5 | 41 |
| 1ST9-24 | G1.1/2"X11 | R1.1/2"X11 | 61 | 62.5 | 48 |
| 1ST9-32 | G2"X11 | R2"X11 | 65 | 75 | 63 |

1B

英制外螺纹60°内锥
BSP MALE 60° SEAT

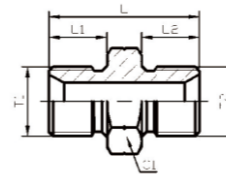

| 产品代号 PART NO | 螺纹 THREAD | | 尺寸 DIMENSIONS | | | |
|-----------------|------------|------------|---------------|------|------|----|
| | T1 | T2 | L1 | L2 | L | S1 |
| 1B-02 | G1/8"X28 | G1/8"X28 | 11 | 11 | 23.5 | 14 |
| 1B-02-04 | G1/8"X28 | G1/4"X19 | 11 | 11 | 28 | 19 |
| 1B-04 | G1/4"X19 | G1/4"X19 | 11 | 11 | 31.5 | 19 |
| 1B-04-06 | G1/4"X19 | G3/8"X19 | 11 | 12 | 33.2 | 22 |
| 1B-04-08 | G1/4"X19 | G1/2"X14 | 11 | 14 | 36.7 | 27 |
| 1B-06 | G3/8"X19 | G3/8"X19 | 12 | 12 | 34.7 | 22 |
| 1B-06-08 | G3/8"X19 | G1/2"X14 | 12 | 14 | 38.2 | 27 |
| 1B-08 | G1/2"X14 | G1/2"X14 | 14 | 14 | 40.7 | 27 |
| 1B-08-10 | G1/2"X14 | G5/8"X14 | 14 | 17.5 | 43.2 | 30 |
| 1B-10 | G5/8"X14 | G5/8"X14 | 17.5 | 17.5 | 45.2 | 30 |
| 1B-10-12 | G5/8"X14 | G3/4"X14 | 17.5 | 16 | 45.2 | 32 |
| 1B-12 | G3/4"X14 | G3/4"X14 | 16 | 16 | 45.2 | 32 |
| 1B-12-16 | G3/4"X14 | G1"X11 | 16 | 19 | 48.9 | 41 |
| 1B-12-20 | G3/4"X14 | G1.1/4"X11 | 16 | 20.5 | 57.4 | 50 |
| 1B-16 | G1"X11 | G1"X11 | 19 | 19 | 51.9 | 41 |
| 1B-16-20 | G1"X11 | G1.1/4"X11 | 19 | 20.5 | 60.4 | 50 |
| 1B-16-24 | G1"X11 | G1.1/2"X11 | 19 | 23 | 64.4 | 55 |
| 1B-20 | G1.1/4"X11 | G1.1/4"X11 | 20.5 | 20.5 | 61.4 | 50 |
| 1B-20-24 | G1.1/4"X11 | G1.1/2"X11 | 20.5 | 23 | 65.4 | 55 |
| 1B-24 | G1.1/2"X11 | G1.1/2"X11 | 23 | 23 | 67.4 | 55 |
| 1B-24-32 | G1.1/2"X11 | G2"X11 | 23 | 25.5 | 72.9 | 70 |
| 1B-32 | G2"X11 | G2"X11 | 25.5 | 25.5 | 76.4 | 70 |

1B9

90°英制外螺纹60°内锥
90°B MALE 60°SEAT

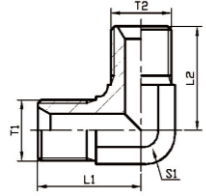

| 产品代号 PART NO. | 螺纹 THREAD | | 尺寸 DIMENSIONS | | |
|------------------|------------|------------|---------------|------|----|
| | T1 | T2 | L1 | L2 | S1 |
| 1B9-02 | G1/8"X28 | G1/8"X28 | 16.6 | 16.6 | 11 |
| 1B9-04 | G1/4"X19 | G1/4"X19 | 27.8 | 27.8 | 14 |
| 1B9-06 | G3/8"X19 | G3/8"X19 | 31.7 | 31.7 | 19 |
| 1B9-08 | G1/2"X14 | G1/2"X14 | 37 | 37 | 22 |
| 1B9-10 | G5/8"X14 | G5/8"X14 | 39 | 39 | 22 |
| 1B9-12 | G3/4"X14 | G3/4"X14 | 41.6 | 41.6 | 27 |
| 1B9-16 | G1"X11 | G1"X11 | 49.7 | 49.7 | 33 |
| 1B9-20 | G1.1/4"X11 | G1.1/4"X11 | 54.4 | 54.4 | 41 |
| 1B9-24 | G1.1/2"X11 | G1.1/2"X11 | 53.7 | 53.7 | 48 |

2B

英管外螺纹60°内锥/英管内螺纹60°外锥
BSP MALE 60°SEAT/B FEMALE 60°CONE

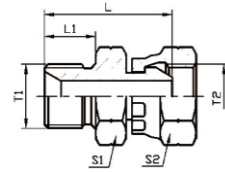

| 产品代号 PART NO. | 螺纹 THREAD | | 尺寸 DIMENSIONS | | | |
|------------------|-----------|----------|---------------|------|----|----|
| | T1 | T2 | L1 | L | S1 | S2 |
| F2B-04 | G1/4"X19 | G1/4"X19 | 11 | 36.6 | 19 | 19 |
| 2B-04-06 | G1/4"X19 | G3/8"X19 | 11 | 38.5 | 22 | 22 |
| 2B-04-08 | G1/4"X19 | G1/2"X14 | 11 | 42 | 27 | 27 |
| 2B-06 | G3/8"X19 | G3/8"X19 | 12 | 40 | 22 | 22 |
| 2B-06-04 | G3/8"X19 | G1/4"X19 | 12 | 38.3 | 22 | 19 |
| 2B-06-08 | G3/8"X19 | G1/2"X14 | 12 | 43.6 | 27 | 27 |
| 2B-08 | G1/2"X14 | G1/2"X14 | 14 | 46.1 | 27 | 27 |
| 2B-08-06 | G1/2"X14 | G3/8"X19 | 14 | 43.5 | 27 | 22 |
| 2B-08-12 | G1/2"X14 | G3/4"X14 | 14 | 48 | 32 | 32 |
| 2B-12 | G3/4"X14 | G3/4"X14 | 16 | 50 | 32 | 32 |
| 2B-12-08 | G3/4"X14 | G1/2"X14 | 16 | 48.6 | 32 | 27 |
| 2B-12-16 | G3/4"X14 | G1"X11 | 16 | 54.3 | 41 | 41 |
| 2B-16 | G1"X11 | G1"X11 | 19 | 57.3 | 41 | 41 |

2B9

90°英管外螺纹60°内锥/英管内螺纹60°外锥
90°BSP MALE 60°SEAT/BSP FEMALE 60°CONE

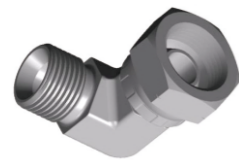
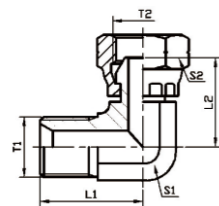

| 产品代号 PART NO. | 螺纹 THREAD | | 尺寸 DIMENSIONS | | | |
|------------------|------------|------------|---------------|------|----|----|
| | T1 | T2 | L1 | L2 | S1 | S2 |
| 2B9-02 | G1/8"X28 | G1/8"X28 | 16.6 | 17.9 | 11 | 14 |
| 2B9-04 | G1/4"X19 | G1/4"X19 | 27.8 | 25.7 | 19 | 19 |
| 2B9-06 | G3/8"X19 | G3/8"X19 | 31.7 | 29.6 | 22 | 22 |
| 2B9-08 | G1/2"X14 | G1/2"X14 | 37 | 33.8 | 27 | 27 |
| 2B9-10 | G5/8"X14 | G5/8"X14 | 39 | 32.1 | 27 | 30 |
| 2B9-12 | G3/4"X14 | G3/4"X14 | 41.6 | 36.3 | 33 | 32 |
| 2B9-16 | G1"X11 | G1"X11 | 49.7 | 42.7 | 41 | 41 |
| 2B9-20 | G1.1/4"X11 | G1.1/4"X11 | 54.4 | 49.5 | 48 | 50 |
| 2B9-24 | G1.1/2"X11 | G1.1/2"X11 | 53.7 | 49.9 | 48 | 55 |

3B

英管内螺纹60°外锥
BSP FEMALE 60°CONE

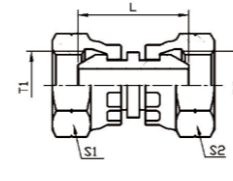

| 产品代号 PART NO. | 螺纹 THREAD | | 尺寸 DIMENSIONS | | |
|------------------|------------|------------|---------------|----|----|
| | T1 | T2 | L | S1 | S2 |
| 3B-04 | G1/4"X19 | G1/4"X19 | 26 | 19 | 19 |
| 3B-04-06 | G1/4"X19 | G3/8"X19 | 26 | 19 | 22 |
| 3B-04-08 | G1/4"X19 | G1/2"X14 | 28.8 | 19 | 27 |
| 3B-06 | G3/8"X19 | G3/8"X19 | 27.5 | 22 | 22 |
| 3B-06-08 | G3/8"X19 | G1/2"X14 | 29.5 | 22 | 27 |
| 3B-08 | G1/2"X14 | G1/2"X14 | 31.5 | 27 | 27 |
| 3B-08-12 | G1/2"X14 | G3/4"X14 | 32 | 27 | 32 |
| 3B-10 | G5/8"X14 | G5/8"X14 | 28.6 | 30 | 30 |
| 3B-12 | G3/4"X14 | G3/4"X14 | 31.5 | 32 | 32 |
| 3B-16 | G1"X11 | G1"X11 | 35 | 41 | 41 |
| 3B-20 | G1.1/4"X11 | G1.1/4"X11 | 45 | 50 | 50 |
| 3B-24 | G1.1/2"X11 | G1.1/2"X11 | 43.2 | 55 | 55 |

1BG

英制外螺纹60°内锥/英管外螺纹O型圈
BSP MALE 60°SEAT/BSP MALE O-RING

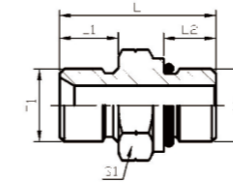

| 产品代号 PART NO. | 螺纹 THREAD | | 尺寸 DIMENSIONS | | | |
|------------------|------------|------------|---------------|------|------|----|
| | T1 | T2 | L1 | L2 | L | S1 |
| 1BG-02 | G1/8"X28 | G1/8"X28 | 10 | 9.5 | 27 | 14 |
| 1BG-04 | G1/4"X19 | G1/4"X19 | 12 | 11 | 31 | 19 |
| 1BG-04-06 | G1/4"X19 | G3/8"X19 | 12 | 11.5 | 32 | 22 |
| 1BG-06 | G3/8"X19 | G3/8"X19 | 13.5 | 11.5 | 33 | 22 |
| 1BG-06-04 | G3/8"X19 | G1/4"X19 | 13.5 | 11 | 32.5 | 22 |
| 1BG-06-08 | G3/8"X19 | G1/2"X14 | 13.5 | 14 | 38.5 | 27 |
| 1BG-08 | G1/2"X14 | G1/2"X14 | 16 | 14 | 41 | 27 |
| 1BG-08-06 | G1/2"X14 | G3/8"X19 | 16 | 11.5 | 36 | 27 |
| 1BG-08-12 | G1/2"X14 | G3/4"X14 | 16 | 15.5 | 45.5 | 32 |
| 1BG-10-08 | G5/8"X14 | G1/2"X14 | 17.5 | 14 | 44.5 | 30 |
| 1BG-12 | G3/4"X14 | G3/4"X14 | 18.5 | 15 | 46 | 32 |
| 1BG-12-08 | G3/4"X14 | G1/2"X14 | 18.5 | 14 | 45.5 | 32 |
| 1BG-16 | G1"X11 | G1"X11 | 20.5 | 18 | 53 | 41 |
| 1BG-16-12 | G1"X11 | G3/4"X14 | 20.5 | 15 | 52 | 41 |
| 1BG-20 | G1.1/4"X11 | G1.1/4"X11 | 20.5 | 20 | 58.5 | 50 |
| 1BG-24 | G1.1/2"X11 | G1.1/2"X11 | 23 | 22 | 62 | 55 |

1BG4-OG

45°弯英管外螺纹60°内锥/英管外螺纹O型圈可调向柱端
45°ELBOW BSP MALE 60°SAET/BSP MALE O-RING ADJUSTABLE STUD END

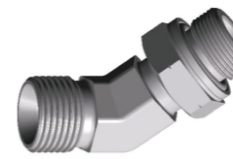
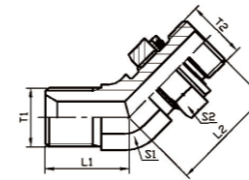

| 产品代号 PART NO. | 螺纹 THREAD | | 尺寸 DIMENSIONS | | | |
|------------------|------------|------------|---------------|------|----|----|
| | T1 | T2 | L1 | L2 | S1 | S2 |
| 1BG4-04OG | G1/4"X19 | G1/4"X19 | 22 | 28 | 14 | 19 |
| 1BG4-04-06OG | G1/4"X19 | G3/8"X19 | 21 | 30 | 16 | 22 |
| 1BG4-04-08OG | G1/4"X19 | G1/2"X14 | 22.5 | 36 | 22 | 27 |
| 1BG4-06OG | G3/8"X19 | G3/8"X19 | 21 | 30 | 17 | 22 |
| 1BG4-06-08OG | G3/8"X19 | G1/2"X14 | 23.5 | 36 | 22 | 27 |
| 1BG4-08OG | G1/2"X14 | G1/2"X14 | 27 | 36 | 22 | 27 |
| 1BG4-12OG | G3/4"X14 | G3/4"X14 | 32 | 42 | 27 | 32 |
| 1BG4-12-16OG | G3/4"X14 | G1"X11 | 32.5 | 44 | 33 | 41 |
| 1BG4-16OG | G1"X11 | G1"X11 | 34 | 44 | 33 | 41 |
| 1BG4-20OG | G1.1/4"X11 | G1.1/4"X11 | 38.5 | 47.5 | 41 | 50 |
| 1BG4-24OG | G1.1/2"X11 | G1.1/2"X11 | 44 | 51.5 | 48 | 55 |

1BG9-OG

90°弯管外螺纹60°内锥/英管外螺纹O形圈可调向柱端
90°ELBOW BSP MALE 60°SAET/BSP MALE O-RING ADJUSTABLE STUD END

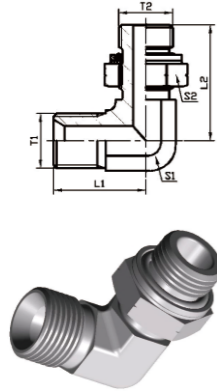

| 产品代号 PART NO. | 螺纹 THREAD | | O形圈 O-RING F端 | 尺寸 DIMENSIONS | | | |
|------------------|------------|------------|------------------|---------------|------|----|----|
| | T1 | T2 | | L1 | L2 | S1 | S2 |
| 1BG9-04OG | G1/4"X19 | G1/4"X19 | O111 | 25 | 31.5 | 14 | 19 |
| 1BG9-04-06OG | G1/4"X19 | G3/8"X19 | O113 | 26.5 | 36.8 | 16 | 22 |
| 1BG9-06OG | G3/8"X19 | G3/8"X19 | O113 | 28 | 36.8 | 16 | 22 |
| 1BG9-06-08OG | G3/8"X19 | G1/2"X14 | O115 | 31 | 43.2 | 22 | 27 |
| 1BG9-08OG | G1/2"X14 | G1/2"X14 | O115 | 34.5 | 43.2 | 22 | 27 |
| 1BG9-08-12OG | G1/2"X14 | G3/4"X14 | O119 | 40 | 49.3 | 27 | 32 |
| 1BG9-12OG | G3/4"X14 | G3/4"X14 | O119 | 40 | 49.3 | 27 | 32 |
| 1BG9-12-16OG | G3/4"X14 | G1"X11 | O217 | 45 | 53 | 33 | 41 |
| 1BG9-16OG | G1"X11 | G1"X11 | O217 | 46 | 53 | 33 | 41 |
| 1BG9-20-16OG | G1.1/4"X11 | G1"X11 | O217 | 50.5 | 58 | 41 | 41 |
| 1BG9-20OG | G1.1/4"X11 | G1.1/4"X11 | O222 | 51.5 | 58 | 41 | 50 |
| 1BG9-24OG | G1.1/2"X11 | G1.1/2"X11 | O224 | 58.5 | 63 | 48 | 55 |

1BT

英管外螺纹60°内锥/英锥管外螺纹
BSP MALE 60°SEAT/BSPT MALE

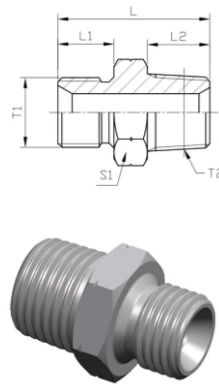

| 产品代号 PART NO. | 螺纹 THREAD | | 尺寸 DIMENSIONS | | | |
|------------------|------------|------------|---------------|------|------|----|
| | T1 | T2 | L1 | L2 | L | S1 |
| 1BT-02 | G1/8"X28 | R1/8"X28 | 10 | 10.5 | 26 | 14 |
| 1BT-02-04 | G1/8"X28 | R1/4"X19 | 10 | 14.5 | 30.5 | 17 |
| 1BT-04 | G1/4"X19 | R1/4"X19 | 12 | 14.5 | 32 | 19 |
| 1BT-04-02 | G1/4"X19 | R1/8"X28 | 12 | 10.5 | 28.5 | 19 |
| 1BT-04-06 | G1/4"X19 | R3/8"X19 | 12 | 15 | 32 | 19 |
| 1BT-06 | G3/8"X19 | R3/8"X19 | 13.5 | 15 | 35.5 | 22 |
| 1BT-06-04 | G3/8"X19 | R1/4"X19 | 13.5 | 14.5 | 35.5 | 22 |
| 1BT-06-08 | G3/8"X19 | R1/2"X14 | 13.5 | 19 | 42.5 | 24 |
| 1BT-08 | G1/2"X14 | R1/2"X14 | 16 | 20 | 45 | 27 |
| 1BT-08-06 | G1/2"X14 | R3/8"X19 | 16 | 15 | 40 | 27 |
| 1BT-08-12 | G1/2"X14 | R3/4"X14 | 16 | 20 | 45 | 30 |
| 1BT-10-08 | G5/8"X14 | R1/2"X14 | 17.5 | 20 | 46.5 | 30 |
| 1BT-10-12 | G5/8"X14 | R3/4"X14 | 17.5 | 20 | 46.5 | 30 |
| 1BT-12 | G3/4"X14 | R3/4"X14 | 18.5 | 20 | 48.5 | 32 |
| 1BT-12-08 | G3/4"X14 | R1/2"X14 | 18.5 | 20 | 49.5 | 32 |
| 1BT-12-16 | G3/4"X14 | R1" X11 | 18.5 | 25.5 | 53.5 | 36 |
| 1BT-16 | G1" X11 | R1" X11 | 20.5 | 25.5 | 58 | 41 |
| 1BT-16-12 | G1" X11 | R3/4"X14 | 20.5 | 20 | 53 | 41 |
| 1BT-16-20 | G1" X11 | R1.1/4"X11 | 20.5 | 26.5 | 60 | 46 |
| 1BT-20 | G1.1/4"X11 | R1.1/4"X11 | 26 | 25 | 65 | 50 |
| 1BT-20-16 | G1.1/4"X11 | R1" X11 | 20.5 | 25.5 | 61 | 50 |
| 1BT-20-24 | G1.1/4"X11 | R1.1/2"X11 | 20.5 | 26.5 | 62 | 50 |
| 1BT-24 | G1.1/2"X11 | R1.1/2"X11 | 29 | 25 | 71 | 55 |
| 1BT-24-20 | G1.1/2"X11 | R1.1/4"X11 | 23 | 26.5 | 64.5 | 55 |
| 1BT-24-32 | G1.1/2"X11 | R2" X11 | 23 | 30 | 70 | 65 |
| 1BT-32 | G2" X11 | R2" X11 | 25.5 | 30 | 72.5 | 70 |
| 1BT-32-24 | G2" X11 | R1.1/2"X11 | 25.5 | 26.5 | 68.5 | 70 |

1B-WD

英制外螺纹60°内锥/英管外螺纹胶垫密封
BSP MALE 60°SEAT/BSP MALE CAPTIVE SEAL

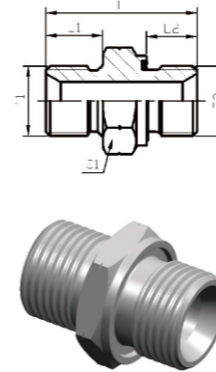

| 产品代号 PART NO. | 螺纹 THREAD | | 尺寸 DIMENSIONS | | | |
|------------------|------------|------------|---------------|----|------|----|
| | T1 | T2 | L2 | L2 | L | S1 |
| 1B-02WD | G1/8"X28 | G1/8"X28 | 10 | 8 | 25.5 | 14 |
| 1B-04WD | G1/4"X19 | G1/4"X19 | 12 | 12 | 32 | 19 |
| 1B-06WD | G3/8"X19 | G3/8"X19 | 13.5 | 12 | 34 | 22 |
| 1B-08WD | G1/2"X14 | G1/2"X14 | 16 | 14 | 43 | 27 |
| 1B-12WD | G3/4"X14 | G3/4"X14 | 18.5 | 16 | 46.5 | 32 |
| 1B-16WD | G1" X11 | G1" X11 | 20.5 | 18 | 54.5 | 41 |
| 1B-20WD | G1.1/4"X11 | G1.1/4"X11 | 20.5 | 20 | 58.5 | 50 |
| 1B-24WD | G1.1/2"X11 | G1.1/2"X11 | 23 | 22 | 63 | 55 |
| 1B-32WD | G2" X11 | G2" X11 | 25.5 | 22 | 66.5 | 75 |

1BT4

45°英管外螺纹60°内锥/英锥管外螺纹
45°BSP MALE 60°SEAT/BSPT MALE

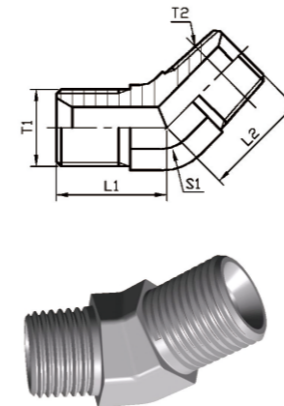

| 产品代号 PART NO. | 螺纹 THREAD | | 尺寸 DIMENSIONS | | |
|------------------|------------|------------|---------------|------|----|
| | T1 | T2 | L1 | L2 | S1 |
| 1BT4-02 | G1/8"X28 | R1/8"X28 | 17 | 17 | 11 |
| 1BT4-04 | G1/4"X19 | R1/4"X19 | 20.3 | 21 | 14 |
| 1BT4-04-06 | G1/4"X19 | R3/8"X19 | 20.5 | 23 | 16 |
| 1BT4-06 | G3/8"X19 | R3/8"X19 | 21 | 23 | 19 |
| 1BT4-06-04 | G3/8"X19 | R1/4"X19 | 22 | 21 | 16 |
| 1BT4-06-08 | G3/8"X19 | R1/2"X14 | 24 | 29.5 | 22 |
| 1BT4-08 | G1/2"X14 | R1/2"X14 | 26 | 30 | 24 |
| 1BT4-08-06 | G1/2"X14 | R3/8"X19 | 27 | 25 | 22 |
| 1BT4-08-12 | G1/2"X14 | R3/4"X14 | 28.5 | 30.5 | 27 |
| 1BT4-10-08 | G5/8"X14 | R1/2"X14 | 28.5 | 29.5 | 22 |
| 1BT4-10-12 | G5/8"X14 | R3/4"X14 | 29 | 35 | 27 |
| 1BT4-12 | G3/4"X14 | R3/4"X14 | 31 | 30.5 | 27 |
| 1BT4-12-08 | G3/4"X14 | R1/2"X14 | 31 | 30.5 | 27 |
| 1BT4-12-16 | G3/4"X14 | R1" X11 | 32.5 | 38 | 33 |
| 1BT4-16 | G1" X11 | R1" X11 | 35 | 38 | 36 |
| 1BT4-16-12 | G1" X11 | R3/4" X14 | 35 | 32.5 | 33 |
| 1BT4-16-20 | G1" X11 | R1.1/4"X11 | 38.5 | 43 | 41 |
| 1BT4-20 | G1.1/4"X11 | R1.1/4"X11 | 38.5 | 43 | 41 |
| 1BT4-20-16 | G1.1/4"X11 | R1" X11 | 38.5 | 42 | 41 |
| 1BT4-20-24 | G1.1/4"X11 | R1.1/2"X11 | 41.5 | 47.5 | 48 |
| 1BT4-24 | G1.1/2"X11 | R1.1/2"X11 | 39 | 47 | 47 |
| 1BT4-24-20 | G1.1/2"X11 | R1.1/4"X11 | 44 | 45.5 | 48 |
| 1BT4-24-32 | G1.1/2"X11 | R2" X11 | 51 | 60.5 | 63 |
| 1BT4-32 | G2" X11 | R2" X11 | 51 | 55.5 | 63 |
| 1BT4-32-24 | G2" X11 | R1.1/2"X11 | 51 | 52.5 | 63 |

1BT9

90°英管外螺纹60°内锥/英锥管外螺纹
90°BSP MALE 60°SEAT/BSPT MALE

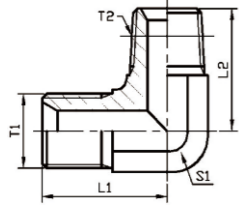

| 产品代号 PART NO | 螺纹 THREAD | | 尺寸 DIMENSIONS | | |
|-----------------|-------------|-------------|---------------|------|----|
| | T1 | T2 | L1 | L2 | S1 |
| 1BT9-02 | G1/8" X28 | R1/8" X28 | 22 | 24 | 14 |
| 1BT9-02-04 | G1/8" X28 | R1/4" X19 | 22.3 | 25.5 | 14 |
| 1BT9-04 | G1/4" X19 | R1/4" X19 | 24.5 | 25.5 | 14 |
| 1BT9-04-02 | G1/4" X19 | R1/8" X28 | 25 | 23.5 | 14 |
| 1BT9-04-06 | G1/4" X19 | R3/8" X19 | 25 | 28.5 | 16 |
| 1BT9-06 | G3/8" X19 | R3/8" X19 | 27.5 | 30.5 | 19 |
| 1BT9-06-04 | G3/8" X19 | R1/4" X19 | 27.5 | 26.5 | 17 |
| 1BT9-06-08 | G3/8" X19 | R1/2" X14 | 31 | 36 | 22 |
| 1BT9-08 | G1/2" X14 | R1/2" X14 | 34.5 | 36 | 22 |
| 1BT9-08-06 | G1/2" X14 | R3/8" X19 | 34.5 | 32.5 | 22 |
| 1BT9-08-12 | G1/2" X14 | R3/4" X14 | 37.5 | 43.5 | 27 |
| 1BT9-10-08 | G5/8" X14 | R1/2" X14 | 35 | 36 | 22 |
| 1BT9-10-12 | G5/8" X14 | R3/4" X14 | 39 | 43.5 | 27 |
| 1BT9-12 | G3/4" X14 | R3/4" X14 | 40 | 43.5 | 27 |
| 1BT9-12-08 | G3/4" X14 | R1/2" X14 | 40 | 39.5 | 27 |
| 1BT9-12-16 | G3/4" X14 | R1" X11 | 43.5 | 50 | 33 |
| 1BT9-16 | G1" X11 | R1" X11 | 46 | 50 | 33 |
| 1BT9-16-12 | G1" X11 | R3/4" X14 | 46 | 47.5 | 33 |
| 1BT9-16-20 | G1" X11 | R1.1/4" X11 | 50.5 | 56.5 | 41 |
| 1BT9-20 | G1.1/4" X11 | R1.1/4" X11 | 52 | 59 | 41 |
| 1BT9-20-16 | G1.1/4" X11 | R1" X11 | 52 | 56.5 | 41 |
| 1BT9-20-24 | G1.1/4" X11 | R1.1/2" X11 | 54.5 | 62.5 | 48 |
| 1BT9-24 | G1.1/2" X11 | R1.1/2" X11 | 57.5 | 62.5 | 48 |
| 1BT9-24-20 | G1.1/2" X11 | R1.1/4" X11 | 57.5 | 61 | 48 |
| 1BT9-24-32 | G1.1/2" X11 | R2" X11 | 65 | 75 | 63 |
| 1BT9-32 | G2" X11 | R2" X11 | 67 | 75 | 63 |

4B

英管外螺纹60°内锥或六角端面组合垫密封堵头
BSP MALE DOUBLE USE FOR 60°SEAT OR BONDED SEAL PLUG

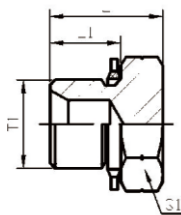

| 产品代号 PART NO. | 螺 纹 T1 THREAD T1 | 尺寸 DIMENSIONS | | |
|------------------|---------------------|---------------|------|----|
| | | L1 | L | S1 |
| 4B-02 | G1/8" X28 | 10 | 16 | 14 |
| 4B-04 | G1/4" X19 | 12 | 18 | 19 |
| 4B-06 | G3/8" X19 | 13.5 | 21.5 | 22 |
| 4B-08 | G1/2" X14 | 16 | 26 | 27 |
| 4B-10 | G5/8" X14 | 17.5 | 27.5 | 30 |
| 4B-12 | G3/4" X14 | 18.5 | 29.5 | 32 |
| 4B-16 | G1" X11 | 20.5 | 34 | 41 |
| 4B-20 | G1.1/4" X11 | 20.5 | 37.5 | 50 |
| 4B-24 | G1.1/2" X11 | 23 | 40 | 55 |
| 4B-32 | G2" X11 | 25.5 | 43.5 | 70 |

4T

英锥管外螺纹堵头
BSPT MALE PLUG

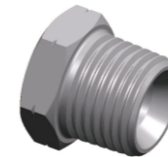
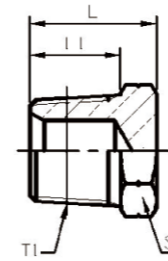

| 产品代号 PART NO. | 螺 纹 T1 THREAD T1 | 尺寸 DIMENSIONS | | |
|------------------|---------------------|---------------|------|----|
| | | L1 | L | S1 |
| 4T-02 | R1/8" X28 | 10 | 16 | 12 |
| 4T-04 | R1/4" X19 | 14.5 | 20 | 17 |
| 4T-06 | R3/8" X19 | 15 | 21 | 19 |
| 4T-08 | R1/2" X14 | 20 | 27 | 22 |
| 4T-12 | R3/4" X14 | 20 | 29 | 30 |
| 4T-16 | R1" X11 | 25.5 | 36.5 | 36 |
| 4T-20 | R1.1/4" X11 | 26.5 | 38.5 | 46 |
| 4T-24 | R1.1/2" X11 | 26.5 | 42 | 50 |
| 4T-32 | R2" X11 | 30 | 46 | 65 |

5B

英管外螺纹60°内锥/英管内螺纹
BSP MALE 60° SEAT/BSP FEMALE
ISO 1179

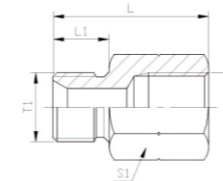

| 产品代号 PART NO. | PART | 螺 纹 THREAD | | 尺寸 DIMENSIONS | | |
|------------------|------|-------------|-------------|---------------|------|----|
| | | T1 | T2 | L1 | L2 | S1 |
| 5B-02-04 | | G1/8" X28 | G1/4" X19 | 11 | 32 | 19 |
| 5B-02-06 | | G1/8" X28 | G3/8" X19 | 11 | 35 | 22 |
| 5B-04 | | G1/4" X19 | G1/4" X19 | 12 | 33 | 19 |
| 5B-04-02 | | G1/4" X19 | G1/8" X28 | 12 | 28.5 | 19 |
| 5B-04-06 | | G1/4" X19 | G3/8" X19 | 12 | 36 | 22 |
| 5B-04-08 | | G1/4" X19 | G1/2" X14 | 12 | 41 | 27 |
| 5B-06 | | G3/8" X19 | G3/8" X19 | 13.5 | 37.5 | 22 |
| 5B-06-04 | | G3/8" X19 | G1/4" X19 | 13.5 | 35 | 22 |
| 5B-06-08 | | G3/8" X19 | G1/2" X14 | 13.5 | 42.5 | 27 |
| 5B-08 | | G1/2" X14 | G1/2" X14 | 16 | 45 | 27 |
| 5B-08-04 | | G1/2" X14 | G1/4" X19 | 16 | 26 | 27 |
| 5B-08-06 | | G1/2" X14 | G3/8" X19 | 16 | 40 | 27 |
| 5B-08-12 | | G1/2" X14 | G3/4" X14 | 16 | 46 | 36 |
| 5B-12 | | G3/4" X14 | G3/4" X14 | 18.5 | 48 | 36 |
| 5B-12-08 | | G3/4" X14 | G1/2" X14 | 18.5 | 47.5 | 32 |
| 5B-12-16 | | G3/4" X14 | G1" X11 | 18.5 | 53.5 | 41 |
| 5B-12-20 | | G3/4" X14 | G1.1/4" X11 | 18.5 | 54.5 | 50 |
| 5B-16 | | G1" X11 | G1" X11 | 20.5 | 55.5 | 41 |
| 5B-16-12 | | G1" X11 | G3/4" X14 | 20.5 | 50.5 | 41 |
| 5B-16-20 | | G1" X11 | G1.1/4" X11 | 20.5 | 56.5 | 50 |
| 5B-20 | | G1.1/4" X11 | G1.1/4" X11 | 20.5 | 55 | 50 |
| 5B-20-16 | | G1.1/4" X11 | G1" X11 | 20.5 | 52 | 50 |
| 5B-20-24 | | G1.1/4" X11 | G1.1/2" X11 | 20.5 | 58.5 | 55 |
| 5B-24 | | G1.1/2" X11 | G1.1/2" X11 | 23 | 61 | 55 |
| 5B-24-16 | | G1.1/2" X11 | G1" X11 | 23 | 43.5 | 55 |
| 5B-24-20 | | G1.1/2" X11 | G1.1/4" X11 | 23 | 59 | 55 |
| 5B-24-32 | | G1.1/2" X11 | G2" X11 | 23 | 64 | 70 |
| 5B-32 | | G2" X11 | G2" X11 | 26 | 63 | 70 |

5B-WD

英管外螺纹胶垫密封/英管内螺纹
BSP MALE CAPTIVE SEAL/BSP FEMALE
ISO 1179

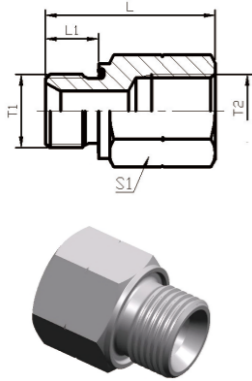

| 产品代号 NO. | PART | 螺纹 THREAD | | 尺寸 DIMENSIONS | | |
|-------------|------|------------|------------|---------------|------|----|
| | | T1 | T2 | L1 | L2 | S1 |
| 5B-02-04WD | | G1/8"X28 | G1/4"X19 | 11 | 32 | 19 |
| 5B-02-06WD | | G1/8"X28 | G3/8"X19 | 8 | 33.5 | 22 |
| 5B-04-02WD | | G1/4"X19 | G1/8"X28 | 12 | 31.5 | 19 |
| 5B-04-06WD | | G1/4"X19 | G3/8"X19 | 12 | 37 | 22 |
| 5B-04-08WD | | G1/4"X19 | G1/2"X14 | 12 | 43 | 27 |
| 5B-06-02WD | | G3/8"X19 | G1/8"X28 | 12 | 35.5 | 22 |
| 5B-06-04WD | | G3/8"X19 | G1/4"X19 | 12 | 37.5 | 22 |
| 5B-06-08WD | | G3/8"X19 | G1/2"X14 | 12 | 43.5 | 27 |
| 5B-08-04WD | | G1/2"X14 | G1/4"X19 | 14 | 38 | 27 |
| 5B-08-06WD | | G1/2"X14 | G3/8"X19 | 14 | 41 | 27 |
| 5B-08-12WD | | G1/2"X14 | G3/4"X14 | 14 | 46 | 36 |
| 5B-12-08WD | | G3/4"X14 | G1/2"X14 | 16 | 47.5 | 32 |
| 5B-12-16WD | | G3/4"X14 | G1" X11 | 16 | 53.5 | 41 |
| 5B-12-20WD | | G3/4"X14 | G1.1/4"X11 | 16 | 54.5 | 50 |
| 5B-16-12WD | | G1" X11 | G3/4"X14 | 18 | 50.5 | 41 |
| 5B-16-20WD | | G1" X11 | G1.1/4"X11 | 18 | 56.5 | 50 |
| 5B-20-16WD | | G1.1/4"X11 | G1" X11 | 20 | 57.5 | 50 |
| 5B-20-24WD | | G1.1/4"X11 | G1.1/2"X11 | 20 | 59.5 | 55 |
| 5B-20-32WD | | G1.1/4"X11 | G2" X11 | 20 | 64 | 70 |
| 5B-24-16WD | | G1.1/2"X11 | G1" X11 | 22 | 59.5 | 55 |
| 5B-24-20WD | | G1.1/2"X11 | G1.1/4"X11 | 22 | 60 | 55 |
| 5B-24-32WD | | G1.1/2"X11 | G2" X11 | 22 | 66 | 70 |

1BW

英管外螺纹60°内锥或六角端面用组合垫密封/焊接管
BSP MALE DOUBLE USE FOR 60°SEAT OR BONDED SEAL/BUTT-WELD TUBE

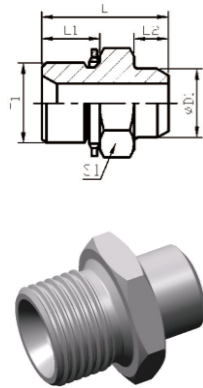

| 产品代号 PART NO. | 螺 纹 THREAD T1 | 管子直径D1 TUBE O.D D1 | 尺寸 DIMENSIONS | | | |
|------------------|------------------|-----------------------|---------------|----|------|----|
| | | | L1 | L2 | L | S1 |
| 1BW-04-10 | G1/4"X19 | 10 | 12 | 7 | 25 | 19 |
| 1BW-06-14 | G3/8"X19 | 14 | 13.5 | 8 | 29.5 | 22 |
| 1BW-08-18 | G1/2"X14 | 18 | 16 | 10 | 36 | 27 |
| 1BW-12-22 | G3/4"X14 | 22 | 18.5 | 10 | 39.5 | 32 |
| 1BW-12-28 | G3/4"X14 | 28 | 18.5 | 12 | 41.5 | 32 |
| 1BW-16-28 | G1" X11 | 28 | 20.5 | 12 | 45.5 | 41 |
| 1BW-16-30 | G1" X11 | 30 | 20.5 | 12 | 45.5 | 41 |
| 1BW-20-34 | G1.1/4"X11 | 34 | 20.5 | 14 | 49.5 | 50 |
| 1BW-20-36 | G1.1/4"X11 | 36 | 20.5 | 14 | 49.5 | 50 |
| 1BW-20-42 | G1.1/4"X11 | 42 | 20.5 | 16 | 51.5 | 50 |
| 1BW-24-36 | G1.1/2"X11 | 36 | 23 | 14 | 52 | 55 |
| 1BW-24-42 | G1.1/2"X11 | 42 | 23 | 16 | 54 | 55 |
| 1BW-24-50 | G1.1/2"X11 | 50 | 23 | 16 | 54 | 55 |

5T

英锥管外螺纹/英锥管内螺纹
BSPT MALE /BSPT FEMALE

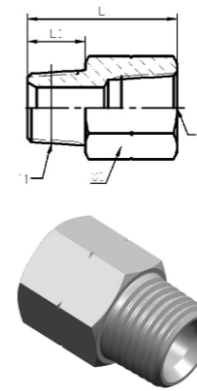

| 产品代号 PART NO. | 螺纹 THREAD | | 尺寸 DIMENSIONS | | |
|------------------|------------|-------------|---------------|------|----|
| | T1 | T2 | L1 | L | S1 |
| 5T-02-04 | R1/8"X28 | Rc1/4"X19 | 10 | 32.5 | 19 |
| 5T-04-02 | R1/4"X19 | Rc1/8"X28 | 14.5 | 20.5 | 14 |
| 5T-04 | R1/4"X19 | Rc1/4"X19 | 14.5 | 36 | 19 |
| 5T-04-06 | R1/4"X19 | Rc3/8"X19 | 14.5 | 38 | 22 |
| 5T-06-04 | R3/8"X19 | Rc1/4"X19 | 15 | 23 | 19 |
| 5T-06 | R3/8"X19 | Rc3/8"X19 | 15 | 38.5 | 22 |
| 5T-06-08 | R3/8"X19 | Rc1/2"X14 | 15 | 44 | 27 |
| 5T-08-04 | R1/2"X14 | Rc1/4"X19 | 20 | 30 | 24 |
| 5T-08-06 | R1/2"X14 | Rc3/8"X19 | 20 | 30 | 24 |
| 5T-08 | R1/2"X14 | Rc1/2"X14 | 20 | 49 | 27 |
| 5T-08-12 | R1/2"X14 | Rc3/4"X14 | 20 | 51 | 36 |
| 5T-12-06 | R3/4"X14 | Rc3/8"X19 | 20 | 31 | 30 |
| 5T-12-08 | R3/4"X14 | Rc1/2"X14 | 20 | 31 | 30 |
| 5T-12 | R3/4"X14 | Rc3/4"X14 | 20 | 51 | 36 |
| 5T-12-16 | R3/4"X14 | Rc1" X11 | 20 | 56.5 | 41 |
| 5T-16-08 | R1"X11 | Rc1/2"X14 | 25.5 | 37 | 36 |
| 5T-16-12 | R1"X11 | Rc3/4"X14 | 25.5 | 37 | 36 |
| 5T-16 | R1"X11 | Rc1"X11 | 25.5 | 60 | 41 |
| 5T-16-20 | R1"X11 | Rc1.1/4"X11 | 25.5 | 64 | 50 |
| 5T-20-12 | R1.1/4"X11 | Rc3/4"X14 | 26.5 | 38 | 46 |
| 5T-20-16 | R1.1/4"X11 | Rc1"X11 | 26.5 | 38 | 46 |
| 5T-20 | R1.1/4"X11 | Rc1.1/4"X11 | 26.5 | 64.5 | 50 |
| 5T-24-16 | R1.1/2"X11 | Rc1"X11 | 26.5 | 41 | 50 |
| 5T-24-20 | R1.1/2"X11 | Rc1.1/4"X11 | 26.5 | 41 | 50 |
| 5T-32-20 | R2"X11 | Rc1.1/4"X11 | 30 | 45 | 65 |
| 5T-32-24 | R2"X11 | Rc1.1/2"X11 | 30 | 45 | 65 |

2WB

焊接管/英管内螺纹60°外锥
BUTT-WELD TUBE/B FEMALE 60° CONE

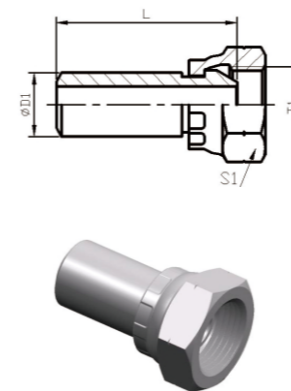

| 产品代号 PART NO. | 螺 纹 THREAD T1 | 管子直径 D1 TUBE O.D D1 | 尺寸 DIMENSIONS | |
|------------------|------------------|------------------------|---------------|----|
| | | | L | S1 |
| 2WB-10-04 | G1/4"X19 | 10 | 35 | 19 |
| 2WB-14-06 | G3/8"X19 | 14 | 40 | 22 |
| 2WB-18-08 | G1/2"X14 | 18 | 50 | 27 |
| 2WB-22-08 | G1/2"X14 | 22 | 50 | 27 |
| 2WB-22-12 | G3/4"X14 | 22 | 62 | 32 |
| 2WB-28-16 | G1" X11 | 28 | 65 | 41 |
| 2WB-34-20 | G1.1/4"X11 | 34 | 68 | 50 |
| 2WB-42-20 | G1.1/4"X11 | 42 | 59.5 | 50 |
| 2WB-50-24 | G1.1/2"X11 | 50 | 57.5 | 55 |

7T

英锥管内螺纹
BSPT FEMALE

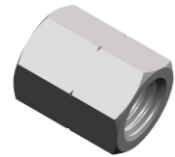
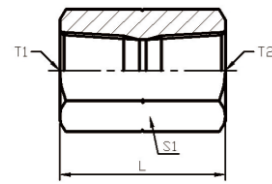

| 产品代号 PART NO. | 螺纹 THREAD | | 尺寸 DIMENSIONS | | | |
|------------------|-------------|-------------|---------------|----|--|--|
| | T1 | T2 | L | S1 | | |
| 7T-02 | Rc1/8"X28 | Rc1/8"X28 | 20 | 14 | | |
| 7T-02-04 | Rc1/8"X28 | Rc1/4"X19 | 30 | 19 | | |
| 7T-04 | Rc1/4"X19 | Rc1/4"X19 | 30 | 19 | | |
| 7T-04-06 | Rc1/4"X19 | Rc3/8"X19 | 30 | 22 | | |
| 7T-04-08 | Rc1/4"X19 | Rc1/2"X14 | 40 | 27 | | |
| 7T-06 | Rc3/8"X19 | Rc3/8"X19 | 30 | 22 | | |
| 7T-06-08 | Rc3/8"X19 | Rc1/2"X14 | 40 | 27 | | |
| 7T-06-12 | Rc3/8"X19 | Rc3/4"X14 | 37 | 36 | | |
| 7T-08 | Rc1/2"X14 | Rc1/2"X14 | 40 | 27 | | |
| 7T-08-12 | Rc1/2"X14 | Rc3/4"X14 | 42 | 36 | | |
| 7T-12 | Rc3/4"X14 | Rc3/4"X14 | 42 | 36 | | |
| 7T-12-16 | Rc3/4"X14 | Rc1"X11 | 50 | 41 | | |
| 7T-16 | Rc1"X11 | Rc1"X11 | 50 | 41 | | |
| 7T-16-20 | Rc1"X11 | Rc1.1/4"X11 | 52 | 50 | | |
| 7T-20 | Rc1.1/4"X11 | Rc1.1/4"X11 | 55 | 50 | | |
| 7T-24 | Rc1.1/2"X11 | Rc1.1/2"X11 | 55 | 55 | | |
| 7T-32 | Rc2"X11 | Rc2"X11 | 65 | 70 | | |

1BH

英管外螺纹60°内锥或六角端面用组合垫密封 / 公制外螺纹轻系列ISO 6149-3
BSP MALE DOUBLE FOR 60° SEAT OR BONDED SEAL / METRIC MALE L-SERIES
ISO 6149-3

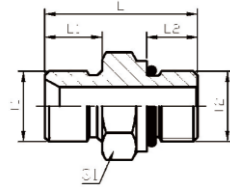

| 产品代号 PART NO. | 螺纹 THREAD | | 尺寸 DIMENSIONS | | | |
|------------------|------------|---------|---------------|------|----|------|
| | E | F | L1 | L2 | S1 | L |
| 1BH-02-10 | G1/8"X28 | M10X1 | 10 | 9.5 | 14 | 25 |
| 1BH-02-12 | G1/8"X28 | M12X1.5 | 10 | 11 | 17 | 28 |
| 1BH-04-12 | G1/4"X19 | M12X1.5 | 12 | 11 | 19 | 30 |
| 1BH-04-14 | G1/4"X19 | M14X1.5 | 12 | 11 | 19 | 31.5 |
| 1BH-04-16 | G1/4"X19 | M16X1.5 | 12 | 12.5 | 22 | 31.5 |
| 1BH-06-14 | G3/8"X19 | M14X1.5 | 13.5 | 11 | 22 | 35 |
| 1BH-06-16 | G3/8"X19 | M16X1.5 | 13.5 | 11.5 | 22 | 33 |
| 1BH-06-18 | G3/8"X19 | M18X1.5 | 13.5 | 12.5 | 24 | 36.5 |
| 1BH-08-18 | G1/2"X14 | M18X1.5 | 16 | 12.5 | 27 | 41 |
| 1BH-08-22 | G1/2"X14 | M22X1.5 | 16 | 13 | 27 | 41.5 |
| 1BH-10-22 | G5/8"X14 | M22X1.5 | 17.5 | 13 | 30 | 43 |
| 1BH-12-22 | G3/4"X14 | M22X1.5 | 18.5 | 13 | 32 | 45 |
| 1BH-12-27 | G3/4"X14 | M27X2 | 18.5 | 16 | 32 | 45.5 |
| 1BH-16-27 | G1"X11 | M27X2 | 20.5 | 16 | 41 | 49 |
| 1BH-16-33 | G1"X11 | M33X2 | 20.5 | 16 | 41 | 49.5 |
| 1BH-20-42 | G1.1/4"X11 | M42X2 | 20.5 | 16 | 50 | 51.5 |
| 1BH-24-48 | G1.1/2"X11 | M48X2 | 23 | 17.5 | 55 | 55.5 |

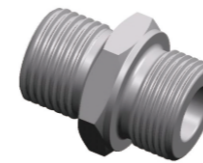
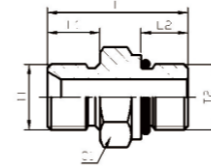

1BO

英管外螺纹60°内锥或六角端面用组合垫密封/美制SAE外螺纹带O形圈轻系列ISO 11926-3
STRAIGHT FITTING MALE DOUBLE USE FOR 60° SEAT OR BONDED SEAL / SAE O-RING BOSS L-SERIES ISO 11926-3

| 产品代号 PART NO. | 螺纹 THREAD | | 尺寸 DIMENSIONS | | | |
|------------------|------------|--------------|---------------|------|------|----|
| | T1 | T2 | L1 | L2 | L | S1 |
| 1BO-04 | G1/4"X19 | 7/16"X20UNF | 12 | 9.1 | 29.5 | 19 |
| 1BO-04-05 | G1/4"X19 | 1/2"X20UNF | 12 | 9.1 | 29.5 | 19 |
| 1BO-04-06 | G1/4"X19 | 9/16"X18UNF | 12 | 9.9 | 32 | 19 |
| 1BO-04-08 | G1/4"X19 | 3/4"X16UNF | 12 | 11.1 | 31 | 22 |
| 1BO-06 | G3/8"X19 | 9/16"X18UNF | 13.5 | 9.9 | 33.5 | 22 |
| 1BO-06-04 | G3/8"X19 | 7/16"X20UNF | 13.5 | 9.1 | 33 | 22 |
| 1BO-06-08 | G3/8"X19 | 3/4"X16UNF | 13.5 | 11.1 | 36 | 24 |
| 1BO-06-10 | G3/8"X19 | 7/8"X14UNF | 13.5 | 12.7 | 39.5 | 27 |
| 1BO-08 | G1/2"X14 | 3/4"X16UNF | 16 | 11.1 | 38 | 27 |
| 1BO-08-06 | G1/2"X14 | 9/16"X18UNF | 16 | 9.9 | 36 | 27 |
| 1BO-08-10 | G1/2"X14 | 7/8"X14UNF | 16 | 12.7 | 42 | 27 |
| 1BO-08-12 | G1/2"X14 | 1.1/16"X12UN | 16 | 15.1 | 42.5 | 36 |
| 1BO-10 | G5/8"X14 | 7/8"X14UNF | 17.5 | 12.7 | 43.5 | 30 |
| 1BO-10-08 | G5/8"X14 | 3/4"X16UNF | 17.5 | 11.1 | 41.5 | 30 |
| 1BO-10-12 | G5/8"X14 | 1.1/16"X12UN | 17.5 | 15.1 | 47 | 34 |
| 1BO-12 | G3/4"X14 | 1.1/16"X12UN | 18.5 | 15.1 | 48 | 34 |
| 1BO-12-08 | G3/4"X14 | 3/4"X16UNF | 18.5 | 11.1 | 40.5 | 32 |
| 1BO-12-10 | G3/4"X14 | 7/8"X14UNF | 18.5 | 12.7 | 45.5 | 32 |
| 1BO-12-14 | G3/4"X14 | 1.3/16"X12UN | 18.5 | 15.1 | 48 | 38 |
| 1BO-12-16 | G3/4"X14 | 1.5/16"X12UN | 18.5 | 15.1 | 50.7 | 41 |
| 1BO-16 | G1"X11 | 1.5/16"X12UN | 20.5 | 15.1 | 52.6 | 41 |
| 1BO-16-10 | G1"X11 | 7/8"X14UNF | 20.5 | 12.7 | 49.5 | 41 |
| 1BO-16-12 | G1"X11 | 1.1/16"X12UN | 20.5 | 15.1 | 52 | 41 |
| 1BO-16-14 | G1"X11 | 1.3/16"X12UN | 20.5 | 15.1 | 52 | 41 |
| 1BO-16-20 | G1"X11 | 1.5/8"X12UN | 20.5 | 15.1 | 54.7 | 50 |
| 1BO-20 | G1.1/4"X11 | 1.5/8"X12UN | 20.5 | 15.1 | 54.7 | 50 |
| 1BO-20-16 | G1.1/4"X11 | 1.5/16"X12UN | 20.5 | 15.1 | 54.7 | 50 |
| 1BO-24 | G1.1/2"X11 | 1.7/8"X12UN | 23 | 15.1 | 57 | 55 |

9B

英制内螺纹60°外锥堵头
BSPT FEMALE 60° CONE PLUG

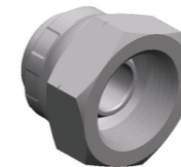
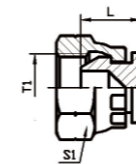

| 产品代号 PART NO. | 螺纹 THREAD | 尺寸 DIMENSIONS | |
|------------------|-------------|---------------|----|
| | T1 | L | S1 |
| 9B-02 | G1/8" X28 | 11.9 | 14 |
| 9B-04 | G1/4" X19 | 15.1 | 19 |
| 9B-06 | G3/8" X19 | 15.8 | 22 |
| 9B-08 | G1/2" X14 | 18.6 | 27 |
| 9B-10 | G5/8" X14 | 17.1 | 30 |
| 9B-12 | G3/4" X14 | 19 | 32 |
| 9B-16 | G1" X11 | 20.5 | 41 |
| 9B-20 | G1.1/4" X11 | 25.5 | 50 |
| 9B-24 | G1.1/2" X11 | 24.6 | 55 |

1BH4-OG

45°英管外螺纹60°内锥或六角端面用组合垫密封 /公制外螺纹轻系列ISO 6149-3
45° BSP MALE DOUBLE FOR 60° SEAT OR BONDED SEAL /METRIC MALE L-SERIES ISO 6149-3

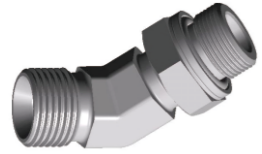
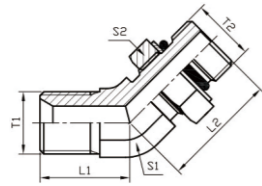

| 产品代号 PART NO. | 螺纹 THREAD | | 尺寸 DIMENSIONS | | | |
|------------------|------------|---------|---------------|------|----|----|
| | T1 | T2 | L1 | L2 | S1 | S2 |
| 1BH4-02-10OG | G1/8"X28 | M10X1 | 17 | 23.5 | 11 | 14 |
| 1BH4-02-12OG | G1/8"X28 | M12X1.5 | 17 | 27.5 | 11 | 17 |
| 1BH4-04-12OG | G1/4"X19 | M12X1.5 | 20.3 | 28.3 | 14 | 17 |
| 1BH4-04-14OG | G1/4"X19 | M14X1.5 | 20.3 | 28.3 | 14 | 19 |
| 1BH4-04-16OG | G1/4"X19 | M16X1.5 | 20.8 | 29.3 | 16 | 22 |
| 1BH4-06-14OG | G3/8"X19 | M14X1.5 | 22.3 | 28.3 | 16 | 19 |
| 1BH4-06-16OG | G3/8"X19 | M16X1.5 | 22.3 | 29.3 | 16 | 22 |
| 1BH4-06-18OG | G3/8"X19 | M18X1.5 | 23 | 31 | 19 | 24 |
| 1BH4-08-18OG | G1/2"X14 | M18X1.5 | 27.3 | 33.3 | 22 | 24 |
| 1BH4-08-22OG | G1/2"X14 | M22X1.5 | 27.3 | 33.3 | 22 | 27 |
| 1BH4-10-22OG | G5/8"X14 | M22X1.5 | 27.8 | 33.3 | 22 | 27 |
| 1BH4-12-22OG | G3/4"X14 | M22X1.5 | 31 | 34.5 | 27 | 27 |
| 1BH4-12-27OG | G3/4"X14 | M27X2 | 31 | 39.5 | 27 | 32 |
| 1BH4-16-27OG | G1" X11 | M27X2 | 34.5 | 40.5 | 33 | 32 |
| 1BH4-16-33OG | G1" X11 | M33X2 | 34.5 | 41 | 33 | 41 |
| 1BH4-20-42OG | G1.1/4"X11 | M42X2 | 39 | 45.5 | 41 | 50 |
| 1BH4-24-48OG | G1.1/2"X11 | M48X2 | 44 | 49.5 | 48 | 55 |

1BH9-OG

90°英管外螺纹60°内锥或六角端面用组合垫密封 /公制外螺纹轻系列ISO 6149-3
90° BSP MALE DOUBLE FOR 60° SEAT OR BONDED SEAL /METRIC MALE L-SERIES ISO 6149-3

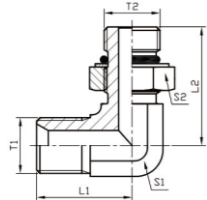

| 产品代号 PART NO. | 螺纹 THREAD | | 尺寸 DIMENSIONS | | | |
|------------------|-------------|---------|---------------|------|----|----|
| | T1 | T2 | L1 | L2 | S1 | S2 |
| 1BH9-02-10OG | G1/8" X28 | M10X1 | 20 | 26.5 | 11 | 14 |
| 1BH9-02-12OG | G1/8" X28 | M12X1.5 | 20 | 30.5 | 11 | 17 |
| 1BH9-04-12OG | G1/4" X19 | M12X1.5 | 24.5 | 32 | 14 | 17 |
| 1BH9-04-14OG | G1/4" X19 | M14X1.5 | 24.5 | 32.5 | 14 | 19 |
| 1BH9-04-16OG | G1/4" X19 | M16X1.5 | 26.5 | 34.5 | 16 | 22 |
| 1BH9-06-14OG | G3/8" X19 | M14X1.5 | 27.5 | 34 | 16 | 19 |
| 1BH9-06-16OG | G3/8" X19 | M16X1.5 | 27.5 | 34.8 | 16 | 22 |
| 1BH9-06-18OG | G3/8" X19 | M18X1.5 | 28.5 | 37 | 19 | 24 |
| 1BH9-08-18OG | G1/2" X14 | M18X1.5 | 34.5 | 39.5 | 22 | 24 |
| 1BH9-08-22OG | G1/2" X14 | M22X1.5 | 34.5 | 40.2 | 22 | 27 |
| 1BH9-10-22OG | G5/8" X14 | M22X1.5 | 35 | 40.2 | 22 | 27 |
| 1BH9-12-22OG | G3/4" X14 | M22X1.5 | 40 | 43.5 | 27 | 27 |
| 1BH9-12-27OG | G3/4" X14 | M27X2 | 40 | 48.5 | 27 | 32 |
| 1BH9-16-27OG | G1" X11 | M27X2 | 46 | 52 | 33 | 32 |
| 1BH9-16-33OG | G1" X11 | M33X2 | 46 | 52.5 | 33 | 41 |
| 1BH9-20-42OG | G1.1/4" X11 | M42X2 | 50.5 | 57.5 | 41 | 50 |
| 1BH9-24-48OG | G1.1/2" X11 | M48X2 | 57.5 | 62.5 | 48 | 55 |

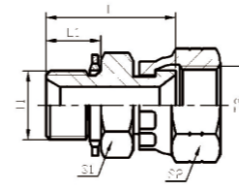

2BJ

英管外螺纹60°内锥或六角端面用组合垫密封/美制JIC内螺纹74°内锥
BSP MALE DOUBLE USE FOR 60° SEAT OR BONDED SEAL /JIC FEMALE 74° SEAT

| 产品代号 PART NO. | 螺纹 THREAD | | 尺寸 DIMENSIONS | | | |
|------------------|------------|------------|---------------|------|----|----|
| | T1 | T2 | L1 | L | S1 | S2 |
| 2BJ-02-04 | G1/8"X28 | 7/16"X20 | 10 | 24 | 14 | 15 |
| 2BJ-02-06 | G1/8"X28 | 9/16"X18 | 10 | 24.5 | 14 | 19 |
| 2BJ-04 | G1/4"X19 | 7/16"X20 | 12 | 26 | 19 | 15 |
| 2BJ-04-05 | G1/4"X19 | 1/2"X20 | 12 | 26.5 | 19 | 17 |
| 2BJ-04-06 | G1/4"X19 | 9/16"X18 | 12 | 27 | 19 | 19 |
| 2BJ-04-08 | G1/4"X19 | 3/4"X16 | 12 | 29 | 19 | 24 |
| 2BJ-06 | G3/8"X19 | 9/16"X18 | 13.5 | 30.5 | 22 | 19 |
| 2BJ-06-08 | G3/8"X19 | 3/4"X16 | 13.5 | 32.5 | 22 | 24 |
| 2BJ-06-10 | G3/8"X19 | 7/8"X14 | 13.5 | 33 | 22 | 27 |
| 2BJ-08 | G1/2"X14 | 3/4"X16 | 16 | 36 | 27 | 24 |
| 2BJ-08-06 | G1/2"X14 | 9/16"X18 | 16 | 35 | 27 | 19 |
| 2BJ-08-10 | G1/2"X14 | 7/8"X14 | 16 | 36.5 | 27 | 27 |
| 2BJ-10 | G5/8"X14 | 7/8"X14 | 17.5 | 37.5 | 30 | 27 |
| 2BJ-12 | G3/4"X14 | 1.1/16"X12 | 18.5 | 42 | 32 | 32 |
| 2BJ-12-08 | G3/4"X14 | 3/4"X16 | 18.5 | 40 | 32 | 24 |
| 2BJ-12-10 | G3/4"X14 | 7/8"X14 | 18.5 | 41 | 32 | 27 |
| 2BJ-12-16 | G3/4"X14 | 1.5/16"X12 | 18.5 | 42 | 32 | 41 |
| 2BJ-16 | G1" X11 | 1.5/16"X12 | 19 | 46.5 | 41 | 41 |
| 2BJ-16-20 | G1" X11 | 1.5/8"X12 | 20.5 | 50 | 41 | 50 |
| 2BJ-20 | G1.1/4"X11 | 1.5/8"X12 | 20.5 | 52 | 50 | 50 |
| 2BJ-20-24 | G1.1/4"X11 | 1.7/8"X12 | 20.5 | 53.5 | 50 | 55 |
| 2BJ-24 | G1.1/2"X11 | 1.7/8"X12 | 23 | 53.5 | 55 | 55 |
| 2BJ-32 | G2" X11 | 2.1/2"X12 | 25.5 | 57.5 | 70 | 75 |

2BJ-WD

英管外螺纹胶垫密封/美制JIC内螺纹74°内锥
BSP MALE CAPTIVE SEAL /JIC FEMALE 74° SEAT

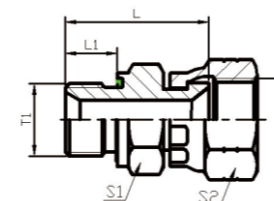

| 产品代号 PART NO. | 螺纹 THREAD | | 尺寸 DIMENSIONS | | | |
|------------------|-------------|-------------|---------------|------|----|----|
| | T1 | T2 | L1 | L | S1 | S2 |
| 2BJ-02-04WD | G1/8" X28 | 7/16" X20 | 8 | 23.5 | 14 | 15 |
| 2BJ-04-05WD | G1/4" X19 | 1/2" X20 | 12 | 28.5 | 19 | 17 |
| 2BJ-04-06WD | G1/4" X19 | 9/16" X18 | 12 | 27 | 19 | 19 |
| 2BJ-04-08WD | G1/4" X19 | 3/4" X16 | 12 | 29 | 19 | 24 |
| 2BJ-04WD | G1/4" X19 | 7/16" X20 | 12 | 28 | 19 | 15 |
| 2BJ-06-08WD | G3/8" X19 | 3/4" X16 | 13.5 | 32.5 | 22 | 24 |
| 2BJ-06WD | G3/8" X19 | 9/16" X18 | 13.5 | 30.5 | 22 | 19 |
| 2BJ-08-06WD | G1/2" X14 | 9/16" X18 | 16 | 35 | 27 | 19 |
| 2BJ-08-10WD | G1/2" X14 | 7/8" X14 | 16 | 36.5 | 27 | 27 |
| 2BJ-08WD | G1/2" X14 | 3/4" X16 | 16 | 36 | 27 | 24 |
| 2BJ-12-16WD | G3/4" X14 | 1.5/16" X12 | 18.5 | 42 | 32 | 41 |
| 2BJ-12WD | G3/4" X14 | 1.1/16" X12 | 18.5 | 42 | 32 | 32 |
| 2BJ-16WD | G1" X11 | 1.5/16" X12 | 19 | 46.5 | 41 | 41 |
| 2BJ-20-16WD | G1.1/4" X11 | 1.5/16" X12 | 20 | 50.5 | 50 | 41 |
| 2BJ-20WD | G1.1/4" X11 | 1.5/8" X12 | 20 | 54.5 | 50 | 50 |
| 2BJ-24WD | G1.1/2" X11 | 1.7/8" X12 | 23 | 52.5 | 55 | 55 |

1BN

英管外螺纹60°内锥或六角端面用组合垫密封/美制布锥管外螺纹
BSP MALE DOUBLE USE FOR 60°SEAT OR BONDED SEAL/NPT MALE

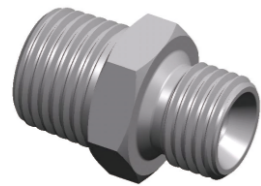
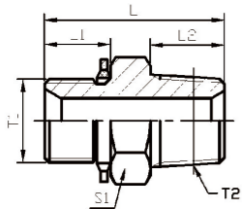

| 产品代号 PART NO. | 螺纹 THREAD | | 尺寸 DIMENSIONS | | | |
|------------------|-----------|-----------|---------------|------|------|----|
| | T1 | T2 | L1 | L2 | L | S1 |
| 1BN-02 | G1/8" X28 | Z1/8" X27 | 10 | 10.1 | 24.4 | 14 |
| 1BN-02-04 | G1/8" X28 | Z1/4" X18 | 10 | 14.6 | 28.9 | 19 |
| 1BN-04 | G1/4" X19 | Z1/4" X18 | 11 | 14.6 | 33.4 | 19 |
| 1BN-04-02 | G1/4" X19 | Z1/8" X27 | 11 | 10.1 | 28.9 | 19 |
| 1BN-04-06 | G1/4" X19 | Z3/8" X18 | 11 | 14.6 | 33.6 | 19 |
| 1BN-06 | G3/8" X19 | Z3/8" X18 | 12 | 14.6 | 35.1 | 22 |
| 1BN-06-04 | G3/8" X19 | Z1/4" X18 | 12 | 14.6 | 35.1 | 22 |
| 1BN-06-08 | G3/8" X19 | Z1/2" X14 | 12 | 19.4 | 39.3 | 22 |
| 1BN-08 | G1/2" X14 | Z1/2" X14 | 14 | 19.4 | 43.4 | 27 |
| 1BN-08-06 | G1/2" X14 | Z3/8" X18 | 14 | 14.6 | 38.6 | 27 |
| 1BN-08-12 | G1/2" X14 | Z3/4" X14 | 14 | 19.4 | 43.9 | 32 |
| 1BN-12 | G3/4" X14 | Z3/4" X14 | 16 | 19.4 | 45.9 | 32 |
| 1BN-12-08 | G3/4" X14 | Z1/2" X14 | 16 | 19.4 | 45.9 | 32 |
| 1BN-12-16 | G3/4" X14 | Z1" X11.5 | 16 | 24.3 | 50.8 | 36 |
| 1BN-16 | G1" X11 | Z1" X11.5 | 19 | 24.3 | 54.5 | 41 |
| 1BN-16-12 | G1" X11 | Z3/4" X14 | 19 | 24.3 | 49.6 | 41 |

1BN9

90°弯英管外螺纹60°内锥面/美制布锥管外螺纹
90° ELBOW BSP MALE 60°SEAT/NPT MALE

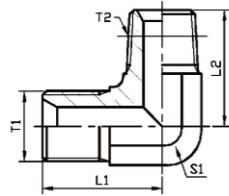

| 产品代号 NO. | PART | 螺纹 THREAD | | 尺寸 DIMENSIONS | | |
|-------------|------|-----------|-----------|---------------|------|----|
| | | T1 | T2 | L1 | L2 | S1 |
| 1BN9-04 | | G1/4" X19 | Z1/4" X18 | 24.5 | 25.5 | 14 |
| 1BN9-04-02 | | G1/4" X19 | Z1/8" X27 | 24.5 | 23.5 | 14 |
| 1BN9-06 | | G3/8" X19 | Z3/8" X18 | 28.5 | 31 | 19 |
| 1BN9-06-04 | | G3/8" X19 | Z1/4" X18 | 27.5 | 26.5 | 16 |
| 1BN9-06-08 | | G3/8" X19 | Z1/2" X14 | 31 | 36.5 | 22 |
| 1BN9-06-12 | | G3/8" X19 | Z3/4" X14 | 34.5 | 44 | 27 |
| 1BN9-08 | | G1/2" X14 | Z1/2" X14 | 34.5 | 37.5 | 22 |
| 1BN9-08-06 | | G1/2" X14 | Z3/8" X18 | 34.5 | 33 | 22 |
| 1BN9-12 | | G3/4" X14 | Z3/4" X14 | 38 | 43.5 | 27 |
| 1BN9-12-08 | | G3/4" X14 | Z1/2" X14 | 39 | 40 | 27 |
| 1BN9-12-16 | | G3/4" X14 | Z1" X11.5 | 43 | 50 | 33 |
| 1BN9-16 | | G1" X11 | Z1" X11.5 | 46 | 50 | 33 |
| 1BN9-16-12 | | G1" X11 | Z3/4" X14 | 46 | 46.5 | 33 |

AB

英管外螺纹60°内锥三通
BSP MALE 60° SEAT TEE

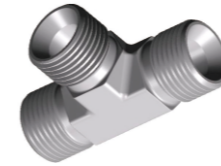
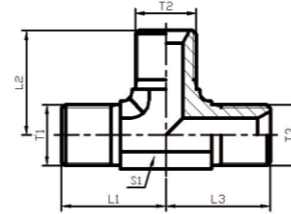

| 产品代号 PART NO. | 螺纹 THREAD | | | 尺寸 DIMENSIONS | | | |
|------------------|-------------|-------------|-------------|---------------|------|------|----|
| | T1 | T2 | T3 | L1 | L2 | L3 | S1 |
| AB-02 | G1/8" X28 | G1/8" X28 | G1/8" X28 | 16.6 | 16.6 | 16.6 | 11 |
| AB-04 | G1/4" X19 | G1/4" X19 | G1/4" X19 | 27.8 | 27.8 | 27.8 | 19 |
| AB-06 | G3/8" X19 | G3/8" X19 | G3/8" X19 | 31.7 | 31.7 | 31.7 | 22 |
| AB-08 | G1/2" X14 | G1/2" X14 | G1/2" X14 | 37 | 37 | 37 | 27 |
| AB-10 | G5/8" X14 | G5/8" X14 | G5/8" X14 | 39 | 39 | 39 | 27 |
| AB-12 | G3/4" X14 | G3/4" X14 | G3/4" X14 | 41.9 | 41.9 | 41.9 | 33 |
| AB-16 | G1" X11 | G1" X11 | G1" X11 | 49.7 | 49.7 | 49.7 | 41 |
| AB-20 | G1.1/4" X11 | G1.1/4" X11 | G1.1/4" X11 | 54.4 | 54.4 | 54.4 | 48 |
| AB-24 | G1.1/2" X11 | G1.1/2" X11 | G1.1/2" X11 | 53.7 | 53.7 | 53.7 | 48 |

BB

英管外螺纹/英管内螺纹/英管外螺纹分支三通
BSP MALE/BSP FEMALE/BSP MALE BRANCH TEE

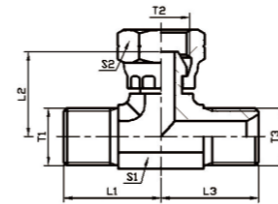

| 产品代号 PART NO. | 螺纹 THREAD | | | 尺寸 DIMENSIONS | | | | |
|------------------|-------------|-------------|-------------|---------------|------|------|----|----|
| | T1 | T2 | T3 | L1 | L2 | L3 | S1 | S2 |
| BB-02 | G1/8" X28 | G1/8" X28 | G1/8" X28 | 16.6 | 16.6 | 17.9 | 11 | 14 |
| BB-04 | G1/4" X19 | G1/4" X19 | G1/4" X19 | 27.8 | 27.8 | 25.7 | 19 | 19 |
| BB-06 | G3/8" X19 | G3/8" X19 | G3/8" X19 | 31.7 | 31.7 | 29.6 | 27 | 22 |
| BB-08 | G1/2" X14 | G1/2" X14 | G1/2" X14 | 37 | 37 | 33.8 | 27 | 27 |
| BB-10 | G5/8" X14 | G5/8" X14 | G5/8" X14 | 39 | 39 | 32.1 | 27 | 30 |
| BB-12 | G3/4" X14 | G3/4" X14 | G3/4" X14 | 41.6 | 41.6 | 36.3 | 33 | 32 |
| BB-16 | G1" X11 | G1" X11 | G1" X11 | 49.7 | 49.7 | 42.7 | 41 | 41 |
| BB-20 | G1.1/4" X11 | G1.1/4" X11 | G1.1/4" X11 | 54.4 | 54.4 | 60 | 48 | 50 |

CB

英锥外螺纹60°内锥/英管外螺纹 60°外锥主支三通
B MALE 60°SEAT/B FEMALE 60° CONE RUN TEE

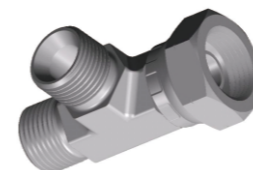
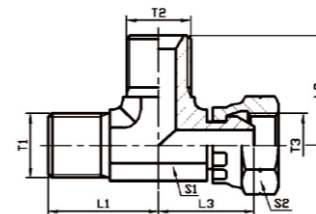

| 产品代号 PART NO. | 螺纹 THREAD | | | 尺寸 DIMENSIONS | | | | |
|------------------|-------------|-------------|-------------|---------------|------|------|----|----|
| | T1 | T2 | T3 | L1 | L2 | L3 | S1 | S2 |
| CB-02 | G1/8" X28 | G1/8" X28 | G1/8" X28 | 16.6 | 16.6 | 17.9 | 11 | 14 |
| CB-04 | G1/4" X19 | G1/4" X19 | G1/4" X19 | 27.8 | 27.8 | 25.7 | 19 | 19 |
| CB-06 | G3/8" X19 | G3/8" X19 | G3/8" X19 | 31.7 | 31.7 | 29.6 | 27 | 22 |
| CB-08 | G1/2" X14 | G1/2" X14 | G1/2" X14 | 37 | 37 | 33.8 | 27 | 27 |
| CB-10 | G5/8" X14 | G5/8" X14 | G5/8" X14 | 39 | 39 | 32.1 | 27 | 30 |
| CB-12 | G3/4" X14 | G3/4" X14 | G3/4" X14 | 41.6 | 41.6 | 36.3 | 33 | 32 |
| CB-16 | G1" X11 | G1" X11 | G1" X11 | 49.7 | 49.7 | 42.7 | 41 | 41 |
| CB-20 | G1.1/4" X11 | G1.1/4" X11 | G1.1/4" X11 | 54.4 | 54.4 | 49.5 | 48 | 50 |

ABBG-OG

英锥外螺纹60°内锥/英管外螺纹O型圈可调向柱端支三通
BSP MALE 60°SEAT/BSP MALE O-RING ADJUSTABLE STUD END RUN TEE

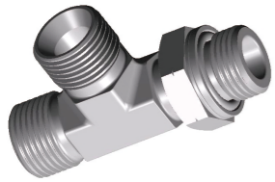
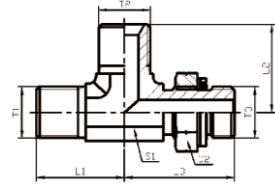

| 产品代号 PART NO. | 螺纹 THREAD | | | 尺寸 DIMENSIONS | | | | | |
|---------------------|-----------|----------|----------|---------------|------|------|----|----|--|
| | T1 | T2 | T3 | L1 | L2 | L3 | S1 | S2 | |
| ABBG-04OG | G1/4"X19 | G1/4"X19 | G1/4"X19 | 24.5 | 24.5 | 31.3 | 14 | 19 | |
| ABBG-04-04-06OG | G1/4"X19 | G1/4"X19 | G3/8"X19 | 26.5 | 26.5 | 35.5 | 16 | 22 | |
| ABBG-06OG | G3/8"X19 | G3/8"X19 | G3/8"X19 | 27.5 | 27.5 | 35.8 | 16 | 22 | |
| ABBG-06-06-08OG | G3/8"X19 | G3/8"X19 | G1/2"X14 | 31 | 31 | 43 | 16 | 27 | |
| ABBG-08OG | G1/2"X14 | G1/2"X14 | G1/2"X14 | 34.5 | 34.5 | 43.2 | 22 | 27 | |
| ABBG-12OG | G3/4"X14 | G3/4"X14 | G3/4"X14 | 40 | 40 | 49.3 | 27 | 32 | |
| ABBG-16OG | G1" X11 | G1" X11 | G1" X11 | 46 | 46 | 53 | 33 | 41 | |

ABGB-OG

英锥外螺纹60°内锥/英管外螺纹O型圈可调向柱端分支三通
BSP MALE 60°SEAT/BSP MALE O-RING ADJUSTABLE STUD END BRANCH TEE

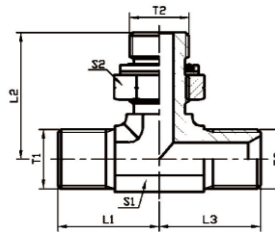

| 产品代号 PART NO. | 螺纹 THREAD | | | 尺寸 DIMENSIONS | | | | | |
|---------------------|-----------|----------|----------|---------------|------|------|----|----|--|
| | T1 | T2 | T3 | L1 | L2 | L3 | S1 | S2 | |
| ABGB-04OG | G1/4"X19 | G1/4"X19 | G1/4"X19 | 25 | 31.8 | 25 | 14 | 19 | |
| ABGB-06-04-06OG | G3/8"X19 | G1/4"X19 | G3/8"X19 | 27.5 | 33.5 | 27.5 | 16 | 19 | |
| ABGB-06OG | G3/8"X19 | G3/8"X19 | G3/8"X19 | 27.5 | 36.8 | 27.5 | 16 | 22 | |
| ABGB-08-06-08OG | G1/2"X14 | G3/8"X19 | G1/2"X14 | 34.5 | 39.5 | 34.5 | 22 | 22 | |
| ABGB-08OG | G1/2"X14 | G1/2"X14 | G1/2"X14 | 34.5 | 43.2 | 34.5 | 22 | 27 | |
| ABGB-12-08-12OG | G3/4"X14 | G1/2"X14 | G3/4"X14 | 40 | 46.5 | 40 | 27 | 27 | |
| ABGB-12OG | G3/4"X14 | G3/4"X14 | G3/4"X14 | 40 | 49.3 | 40 | 27 | 32 | |
| ABGB-16OG | G1" X11 | G1" X11 | G1" X11 | 46 | 53 | 46 | 33 | 41 | |

1F

美制ORFS外螺纹O形圈平面密封
ORFS MALE O-RING

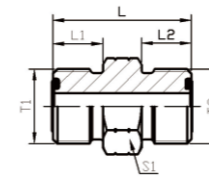

| 产品代号 PART NO. | 螺纹 THREAD | | 尺寸 DIMENSIONS | | | | 重量 (g) | 压力等级MPa |
|------------------|----------------|----------------|---------------|------|------|----|--------|---------|
| | T1 | T2 | L1 | L2 | L | S1 | | |
| 1F-04 | 9/16" X18UNF | 9/16" X18UNF | 10 | 10 | 27.5 | 17 | 37 | 63 |
| 1F-06 | 11/16" X16UN | 11/16" X16UN | 11 | 11 | 31 | 19 | 56 | |
| 1F-08 | 13/16" X16UN | 13/16" X16UN | 13 | 13 | 35.5 | 22 | 80 | |
| 1F-10 | 1" X14UNF | 1" X14UNF | 15.5 | 15.5 | 42.5 | 27 | 143 | 40 |
| 1F-12 | 1.3/16" X12UN | 1.3/16" X12UN | 17 | 17 | 47 | 32 | 216 | |
| 1F-16 | 1.7/16" X12UN | 1.7/16" X12UN | 17.5 | 17.5 | 49.5 | 41 | 332 | |
| 1F-20 | 1.11/16" X12UN | 1.11/16" X12UN | 17.5 | 17.5 | 51.5 | 46 | 419 | 25 |
| 1F-24 | 2" X12UN | 2" X12UN | 17.5 | 17.5 | 53 | 55 | 592 | |

1F9

90°美制ORFS外螺纹O形圈平面密封
90° ORFS MALE O-RING

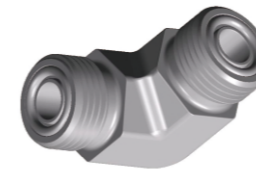
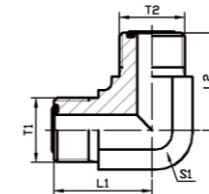

| 产品代号 PART NO. | 螺纹 THREAD | | 尺寸 DIMENSIONS | | | 重量 (g) | 压力等级MPa |
|------------------|----------------|----------------|---------------|------|----|--------|---------|
| | T1 | T2 | L1 | L2 | S1 | | |
| 1F9-04 | 9/16" X18UNF | 9/16" X18UNF | 21.5 | 21.5 | 14 | 42 | 63 |
| 1F9-06 | 11/16" X16UN | 11/16" X16UN | 25.5 | 25.5 | 19 | 72 | |
| 1F9-08 | 13/16" X16UN | 13/16" X16UN | 28 | 28 | 19 | 98 | |
| 1F9-10 | 1" X14UNF | 1" X14UNF | 33.5 | 33.5 | 27 | 176 | 40 |
| 1F9-12 | 1.3/16" X12UN | 1.3/16" X12UN | 37.5 | 37.5 | 30 | 270 | |
| 1F9-16 | 1.7/16" X12UN | 1.7/16" X12UN | 41.5 | 41.5 | 36 | 406 | |
| 1F9-20 | 1.11/16" X12UN | 1.11/16" X12UN | 44.5 | 44.5 | 41 | 541 | 25 |
| 1F9-24 | 2" X12UN | 2" X12UN | 49 | 49 | 50 | 800 | |

6F

6F-LN

美制ORFS外螺纹O形圈平面密封过板接头
ORFS MALE O-RING BULKHEAD

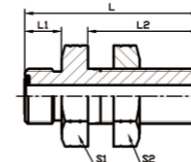
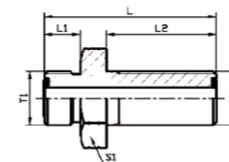

| 产品代号 PART NO. | 螺纹 THREAD | | 尺寸 DIMENSIONS | | | | | 重量 (g) | 压力等级MPa |
|------------------|----------------|----------------|---------------|------|------|----|----|--------|---------|
| | T1 | T2 | L1 | L2 | L | S1 | S2 | | |
| 6F-04 | 9/16" X18UNF | 9/16" X18UNF | 10 | 31.5 | 48 | 22 | 22 | 70 | 63 |
| 6F-06 | 11/16" X16UN | 11/16" X16UN | 11 | 34 | 53 | 27 | 27 | 115 | |
| 6F-08 | 13/16" X16UN | 13/16" X16UN | 13 | 36.5 | 58.5 | 30 | 30 | 158 | |
| 6F-10 | 1" X14UNF | 1" X14UNF | 15.5 | 40.5 | 66.5 | 36 | 36 | 165 | 40 |
| 6F-12 | 1.3/16" X12UN | 1.3/16" X12UN | 17 | 41.5 | 69 | 41 | 41 | 367 | |
| 6F-16 | 1.7/16" X12UN | 1.7/16" X12UN | 17.5 | 42 | 70 | 46 | 46 | 493 | |
| 6F-20 | 1.11/16" X12UN | 1.11/16" X12UN | 17.5 | 42 | 70 | 50 | 50 | 605 | 25 |
| 6F-24 | 2" X12UN | 2" X12UN | 17.5 | 42 | 70 | 60 | 60 | 828 | |

注:如需带锁母订货,则请在代号后加“LN”,如6F-16LN,锁母代号为8F。
Note: In case if you are interested to order the adapter with lock nut, please insert suffix “LN” after our part NO, for example 6F-16LN, The lock nut NO.is 8F.

6F9/6F9-LN

90°弯美制ORFS外螺纹O形圈平面密封过板接头 90° ELBOW ORFS MALE O-RING BULKHEAD

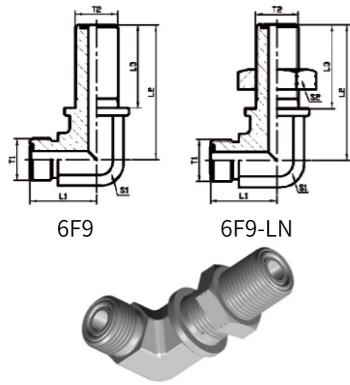

| 产品代号 PART NO. | 螺纹 THREAD | | 尺寸 DIMENSIONS | | | | | 重量 (g) | 压力等级 MPa |
|------------------|---------------|---------------|---------------|------|------|----|----|--------|----------|
| | T1 | T2 | L1 | L2 | L3 | S1 | S2 | | |
| 6F9-04 | 9/16"X18UNF | 9/16"X18UNF | 22.5 | 47 | 31.5 | 14 | 22 | 68 | 63 |
| 6F9-06 | 11/16"X16UN | 11/16"X16UN | 26 | 52 | 34 | 19 | 27 | 110 | |
| 6F9-08 | 13/16"X16UN | 13/16"X16UN | 29 | 55.5 | 36.5 | 19 | 30 | 148 | 40 |
| 6F9-10 | 1"X14UNF | 1"X14UNF | 34.5 | 63 | 40.5 | 27 | 36 | 256 | |
| 6F9-12 | 1.3/16"X12UN | 1.3/16"X12UN | 38.5 | 67 | 41.5 | 30 | 41 | 378 | 25 |
| 6F9-16 | 1.7/16"X12UN | 1.7/16"X12UN | 42.5 | 71 | 42 | 36 | 46 | 555 | |
| 6F9-20 | 1.11/16"X12UN | 1.11/16"X12UN | 45.5 | 75.5 | 42 | 41 | 50 | 736 | 25 |
| 6F9-24 | 2"X12UN | 2"X12UN | 49.5 | 79.5 | 42 | 48 | 60 | 1052 | |

注:如需带锁母订货,则请在代号后加“LN”,如6F9-16LN,锁母代号为8F。
Note: In case if you are interested to order the adapter with lock nut, please insert suffix “LN” after our part NO, for example 6F9-16LN, The lock nut NO.is 8F.

AF

美制ORFS外螺纹O形圈平面密封三通 ORFS MALE O-RING TEE

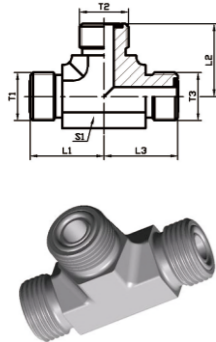

| 产品代号 PART NO. | 螺纹 THREAD | | | 尺寸 DIMENSIONS | | | | 重量 (g) | 压力等级 MPa |
|------------------|---------------|---------------|---------------|---------------|------|------|----|--------|----------|
| | T1 | T2 | T3 | L1 | L2 | L3 | S1 | | |
| AF-04 | 9/16"X18UNF | 9/16"X18UNF | 9/16"X18UNF | 23 | 23 | 23 | 14 | 72 | 63 |
| AF-06 | 11/16"X16UN | 11/16"X16UN | 11/16"X16UN | 25 | 25 | 25 | 19 | 112 | |
| AF-08 | 13/16"X16UN | 13/16"X16UN | 13/16"X16UN | 28 | 28 | 28 | 19 | 156 | 40 |
| AF-10 | 1"X14UNF | 1"X14UNF | 1"X14UNF | 33.3 | 33.3 | 33.3 | 27 | 278 | |
| AF-12 | 1.3/16"X12UN | 1.3/16"X12UN | 1.3/16"X12UN | 37.3 | 37.3 | 37.3 | 30 | 425 | 25 |
| AF-16 | 1.7/16"X12UN | 1.7/16"X12UN | 1.7/16"X12UN | 41.7 | 41.7 | 41.7 | 36 | 648 | |
| AF-20 | 1.11/16"X12UN | 1.11/16"X12UN | 1.11/16"X12UN | 44.7 | 44.7 | 44.7 | 41 | 864 | 25 |
| AF-24 | 2"X12UN | 2"X12UN | 2"X12UN | 48.8 | 48.8 | 48.8 | 48 | 1264 | |

XF

美制ORFS外螺纹O形圈平面密封四通接头 ORFS MALE O-RING CROSS FITTINGS

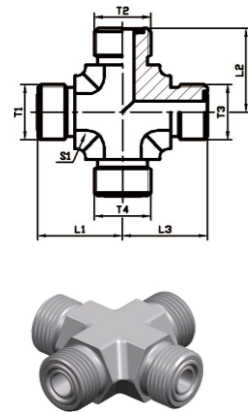

| 产品代号 PART NO. | 螺纹 THREAD | 尺寸 DIMENSIONS | | | | 重量 (g) | 压力等级 MPa |
|------------------|---------------|---------------|------|------|----|--------|----------|
| | T1、T2、T3、T4 | L1 | L2 | L3 | S1 | | |
| XF-04 | 9/16"X18UNF | 21.5 | 21.5 | 21.5 | 14 | 67 | 63 |
| XF-06 | 11/16"X16UN | 25 | 25 | 25 | 19 | 112 | |
| XF-08 | 13/16"X16UN | 28 | 28 | 28 | 19 | 156 | 40 |
| XF-10 | 1"X14UNF | 33.5 | 33.5 | 33.5 | 27 | 280 | |
| XF-12 | 1.3/16"X12UN | 37.5 | 37.5 | 37.5 | 30 | 427 | 25 |
| XF-16 | 1.7/16"X12UN | 41.5 | 41.5 | 41.5 | 36 | 645 | |
| XF-20 | 1.11/16"X12UN | 44.5 | 44.5 | 44.5 | 41 | 860 | 25 |
| XF-24 | 2"X12UN | 49 | 49 | 49 | 50 | 1270 | |

2F9

90°弯美制ORFS外螺纹O形圈平面密封/ORFS内螺纹 90° ELBOW ORFS MALE O-RING FEMALE

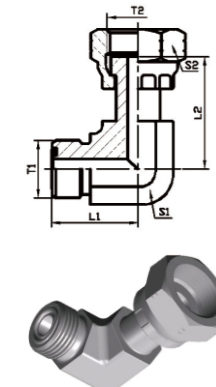

| 产品代号 PART NO. | 螺纹 THREAD | | 尺寸 DIMENSIONS | | | | | 重量 (g) | 压力等级 MPa |
|------------------|---------------|---------------|---------------|------|----|----|-----|--------|----------|
| | T1 | T2 | L1 | L2 | S1 | S2 | | | |
| 2F9-04 | 9/16"X18UNF | 9/16"X18UNF | 21.5 | 26.5 | 14 | 17 | 47 | 63 | |
| 2F9-06 | 11/16"X16UN | 11/16"X16UN | 25 | 29 | 19 | 22 | 76 | | |
| 2F9-08 | 13/16"X16UN | 13/16"X16UN | 28 | 38 | 19 | 24 | 116 | 40 | |
| 2F9-10 | 1"X14UNF | 1"X14UNF | 33.5 | 41 | 27 | 30 | 195 | | |
| 2F9-12 | 1.3/16"X12UN | 1.3/16"X12UN | 37.5 | 46.5 | 30 | 36 | 301 | 25 | |
| 2F9-16 | 1.7/16"X12UN | 1.7/16"X12UN | 41.5 | 53.5 | 36 | 41 | 465 | | |
| 2F9-20 | 1.11/16"X12UN | 1.11/16"X12UN | 44.5 | 58 | 41 | 50 | 623 | 25 | |
| 2F9-24 | 2"X12UN | 2"X12UN | 49 | 61 | 50 | 60 | 897 | | |

2F

美制ORFS外螺纹O形圈平面密封/ORFS内螺纹 ORFS MALE O-RING / ORFS FEMALE

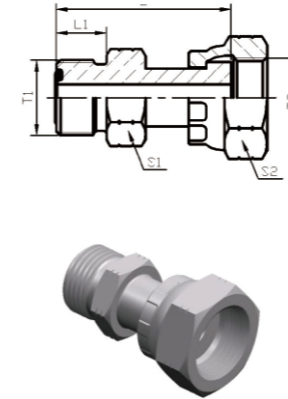

| 产品代号 PART NO. | 螺纹 THREAD | | 尺寸 DIMENSIONS | | | | | 重量 (g) | 压力等级 MPa |
|------------------|---------------|---------------|---------------|------|----|----|-----|--------|----------|
| | T1 | T2 | L1 | L | S1 | S2 | | | |
| 2F-04 | 9/16"X18UNF | 9/16"X18UNF | 9.8 | 33 | 17 | 19 | 37 | 63 | |
| 2F-04-06 | 9/16"X18UNF | 11/16"X16UN | 9.8 | 34.5 | 17 | 22 | 40 | | |
| 2F-04-08 | 9/16"X18UNF | 13/16"X16UN | 9.8 | 36.5 | 19 | 27 | 42 | 40 | |
| 2F-06-04 | 11/16"X16UN | 9/16"X18UNF | 11.2 | 35.5 | 19 | 19 | 57 | | |
| 2F-06 | 11/16"X16UN | 11/16"X16UN | 11.2 | 38.5 | 19 | 22 | 62 | 63 | |
| 2F-06-08 | 11/16"X16UN | 13/16"X16UN | 11.2 | 37.7 | 19 | 27 | 62 | | |
| 2F-06-10 | 11/16"X16UN | 1"X14UNF | 11.2 | 43.7 | 24 | 30 | 73 | 40 | |
| 2F-08-06 | 13/16"X16UN | 11/16"X16UN | 12.8 | 41 | 22 | 22 | 82 | 63 | |
| 2F-08 | 13/16"X16UN | 13/16"X16UN | 12.8 | 43 | 22 | 27 | 89 | 40 | |
| 2F-08-10 | 13/16"X16UN | 1"X14UNF | 12.8 | 45.5 | 24 | 30 | 95 | | |
| 2F-08-12 | 13/16"X16UN | 1.3/16"X12UN | 12.8 | 49 | 30 | 36 | 101 | 63 | |
| 2F-10-08 | 1"X14UNF | 13/16"X16UN | 15.5 | 47.5 | 27 | 27 | 146 | | |
| 2F-10 | 1"X14UNF | 1"X14UNF | 15.5 | 51.5 | 27 | 30 | 156 | 40 | |
| 2F-10-12 | 1"X14UNF | 1.3/16"X12UN | 15.5 | 51.5 | 30 | 36 | 160 | | |
| 2F-10-16 | 1"X14UNF | 1.7/16"X12UN | 15.5 | 56 | 36 | 41 | 172 | 25 | |
| 2F-12-08 | 1.3/16"X12UN | 13/16"X16UN | 17 | 50.5 | 32 | 27 | 213 | | |
| 2F-12-10 | 1.3/16"X12UN | 1"X14UNF | 17 | 54.5 | 32 | 30 | 228 | 63 | |
| 2F-12 | 1.3/16"X12UN | 1.3/16"X12UN | 17 | 56 | 32 | 36 | 236 | 40 | |
| 2F-12-16 | 1.3/16"X12UN | 1.7/16"X12UN | 17 | 58 | 36 | 41 | 245 | | |
| 2F-16-12 | 1.7/16"X12UN | 1.3/16"X12UN | 17.5 | 58 | 38 | 36 | 330 | 25 | |
| 2F-16 | 1.7/16"X12UN | 1.7/16"X12UN | 17.5 | 60 | 38 | 41 | 345 | | |
| 2F-16-20 | 1.7/16"X12UN | 1.11/16"X12UN | 17.5 | 62 | 41 | 50 | 356 | 40 | |
| 2F-20-16 | 1.11/16"X12UN | 1.7/16"X12UN | 17.5 | 58.5 | 46 | 41 | 415 | 25 | |
| 2F-20 | 1.11/16"X12UN | 1.11/16"X12UN | 17.5 | 62 | 46 | 50 | 443 | | |
| 2F-20-24 | 1.11/16"X12UN | 2"X12UN | 17.5 | 65.5 | 50 | 60 | 469 | 25 | |
| 2F-24-20 | 2"X12UN | 1.11/16"X12UN | 17.5 | 64 | 55 | 50 | 607 | | |
| 2F-24 | 2"X12UN | 2"X12UN | 17.5 | 64 | 55 | 60 | 614 | | |

BF

美制ORFS外螺纹O形圈平面密封/美制ORFS内螺纹分支三通 ORFS MALE O-RING/ORFS FEMALE BRANCH TEE

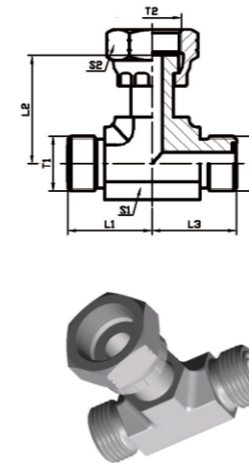

| 产品代号 PART NO. | 螺纹 THREAD | | | 尺寸 DIMENSIONS | | | | | 重量 (g) | 压力等级 MPa |
|------------------|---------------|---------------|---------------|---------------|------|------|----|----|--------|----------|
| | T1 | T2 | T3 | L1 | L2 | L3 | S1 | S2 | | |
| BF-04 | 9/16"X18UNF | 9/16"X18UNF | 9/16"X18UNF | 21.5 | 26.5 | 21.5 | 14 | 19 | 68 | 63 |
| BF-06 | 11/16"X18 | 11/16"X18 | 11/16"X18 | 25 | 29 | 25 | 19 | 22 | 111 | |
| BF-08 | 13/16"X18 | 13/16"X18 | 13/16"X18 | 28 | 38 | 28 | 19 | 27 | 165 | 40 |
| BF-10 | 1"X14UNF | 1"X14UNF | 1"X14UNF | 33.5 | 41 | 33.5 | 27 | 30 | 283 | |
| BF-12 | 1.3/16"X12UN | 1.3/16"X12UN | 1.3/16"X12UN | 37.5 | 46.5 | 37.5 | 30 | 36 | 436 | 25 |
| BF-16 | 1.7/16"X12UN | 1.7/16"X12UN | 1.7/16"X12UN | 41.5 | 53.5 | 41.5 | 36 | 41 | 667 | |
| BF-20 | 1.11/16"X12UN | 1.11/16"X12UN | 1.11/16"X12UN | 44.5 | 58 | 44.5 | 41 | 50 | 895 | 25 |
| BF-24 | 2"X12UN | 2"X12UN | 2"X12UN | 49 | 61 | 49 | 48 | 60 | 1297 | |

CF

美制ORFS外螺纹O形圈平面密封/美制ORFS内螺纹支三通
ORFS MALE O-RING/ORFS FEMALE RUN TEE

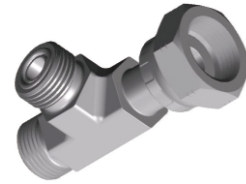
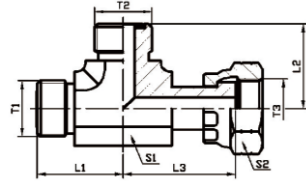

| 产品代号 PART NO. | 螺纹 THREAD | | | 尺寸 DIMENSIONS | | | | | | 重量 (g) | 压力等级 MPa |
|------------------|---------------|---------------|---------------|---------------|------|------|----|----|------|-----------|-------------|
| | T1 | T2 | T3 | L1 | L2 | L3 | S1 | S2 | | | |
| CF-04 | 9/16"X18UNF | 9/16"X18UNF | 9/16"X18UNF | 21.5 | 21.5 | 26.5 | 14 | 19 | 68 | 63 | |
| CF-06 | 11/16"X18 | 11/16"X18 | 11/16"X18 | 25 | 25 | 29 | 19 | 22 | 111 | | |
| CF-08 | 13/16"X18 | 13/16"X18 | 13/16"X18 | 28 | 28 | 38 | 19 | 27 | 165 | | |
| CF-10 | 1"X14UNF | 1"X14UNF | 1"X14UNF | 33.5 | 33.5 | 41 | 27 | 30 | 283 | 40 | |
| CF-12 | 1.3/16"X12UN | 1.3/16"X12UN | 1.3/16"X12UN | 37.5 | 37.5 | 46.5 | 30 | 36 | 436 | | |
| CF-16 | 1.7/16"X12UN | 1.7/16"X12UN | 1.7/16"X12UN | 41.5 | 41.5 | 53.5 | 36 | 41 | 667 | | |
| CF-20 | 1.11/16"X12UN | 1.11/16"X12UN | 1.11/16"X12UN | 44.5 | 44.5 | 58 | 41 | 50 | 895 | 25 | |
| CF-24 | 2"X12UN | 2"X12UN | 2"X12UN | 49 | 49 | 61 | 50 | 60 | 1297 | | |

4F

美制ORFS外螺纹O形圈平面密封堵头
ORFS MALE O-RING PLUG

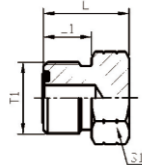

| 产品代号 PART NO. | 螺纹 THREAD | 尺寸 DIMENSIONS | | | 重量 (g) | 压力等级 MPa |
|------------------|---------------|---------------|------|----|--------|-------------|
| | T1 | L1 | L | S1 | | |
| 4F-04 | 9/16"X18UNF | 10 | 16.5 | 17 | 25 | 63 |
| 4F-06 | 11/16"X16UN | 11 | 19 | 19 | 38 | |
| 4F-08 | 13/16"X16UN | 13 | 22 | 22 | 57 | |
| 4F-10 | 1"X14UNF | 15.5 | 26 | 27 | 100 | 40 |
| 4F-12 | 1.3/16"X12UN | 17 | 27.5 | 32 | 145 | |
| 4F-16 | 1.7/16"X12UN | 17.5 | 28 | 41 | 220 | |
| 4F-20 | 1.11/16"X12UN | 17.5 | 28 | 46 | 276 | 25 |
| 4F-24 | 2"X12UN | 17.5 | 28 | 55 | 384 | |

9F

美制ORFS内螺纹堵头 ORFS FEMALE PLUG

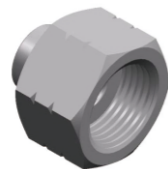
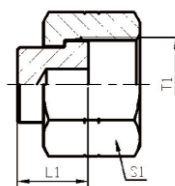

| 产品代号 PART NO. | 螺纹 THREAD | 尺寸 DIMENSIONS | | 重量 (g) | 压力等级 MPa |
|------------------|---------------|---------------|----|--------|-------------|
| | T1 | L1 | S1 | | |
| 9F-04 | 9/16"X18UNF | 8.5 | 19 | 18 | 63 |
| 9F-06 | 11/16"X16UN | 10 | 22 | 19 | |
| 9F-08 | 13/16"X16UN | 11 | 27 | 29 | |
| 9F-10 | 1"X14UNF | 13.5 | 30 | 32 | 40 |
| 9F-12 | 1.3/16"X12UN | 15 | 36 | 54 | |
| 9F-16 | 1.7/16"X12UN | 15 | 41 | 82 | |
| 9F-20 | 1.11/16"X12UN | 15 | 50 | 102 | 25 |
| 9F-24 | 2"X12UN | 16 | 60 | 137 | |

1FN

美制ORFS外螺纹O形圈平面密封/布锥管外螺纹
ORFS MALE O-RING/NPT MALE

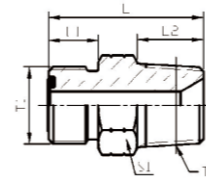

| 产品代号 PART NO. | 螺纹 THREAD | | 尺寸 DIMENSIONS | | | | 重量 (g) | 压力等级 MPa |
|------------------|---------------|--------------|---------------|------|------|----|--------|-------------|
| | T1 | T2 | L1 | L2 | L | S1 | | |
| 1FN-04-02 | 9/16"X18UNF | Z1/8"X27 | 10 | 10 | 27 | 17 | 39 | 34.5 |
| 1FN-04 | 9/16"X18UNF | Z1/4"X18 | 10 | 14.5 | 32 | 17 | 35 | 27.5 |
| 1FN-04-06 | 9/16"X18UNF | Z3/8"X18 | 10 | 14.5 | 33.5 | 19 | 48 | 21 |
| 1FN-04-08 | 9/16"X18UNF | Z1/2"X14 | 10 | 19.5 | 38.5 | 22 | 73 | |
| 1FN-06-04 | 11/16"X16UN | Z1/4"X18 | 11 | 14.5 | 32 | 19 | 43 | 27.5 |
| 1FN-06 | 11/16"X16UN | Z3/8"X18 | 11 | 14.5 | 34 | 19 | 53 | 21 |
| 1FN-06-08 | 11/16"X16UN | Z1/2"X14 | 11 | 19.5 | 39.5 | 22 | 77 | |
| 1FN-08-04 | 13/16"X16UN | Z1/4"X18 | 13 | 14.5 | 37.5 | 22 | 65 | 27.5 |
| 1FN-08-06 | 13/16"X16UN | Z3/8"X18 | 13 | 14.5 | 37.5 | 22 | 70 | 21 |
| 1FN-08 | 13/16"X16UN | Z1/2"X14 | 13 | 19.5 | 41.5 | 22 | 82 | |
| 1FN-08-12 | 13/16"X16UN | Z3/4"X14 | 13 | 19.5 | 43 | 30 | 130 | 17 |
| 1FN-10-06 | 1"X14UNF | Z3/8"X18 | 15.5 | 14.5 | 41.5 | 27 | 111 | 21 |
| 1FN-10-08 | 1"X14UNF | Z1/2"X14 | 15.5 | 19.5 | 46 | 27 | 123 | 21 |
| 1FN-10-12 | 1"X14UNF | Z3/4"X14 | 15.5 | 19.5 | 46 | 30 | 153 | 17 |
| 1FN-12-08 | 1.3/16"X12UN | Z1/2"X14 | 17 | 19.5 | 49 | 32 | 173 | 21 |
| 1FN-12 | 1.3/16"X12UN | Z3/4"X14 | 17 | 19.5 | 49 | 32 | 190 | 17 |
| 1FN-12-16 | 1.3/16"X12UN | Z1"X11.5 | 17 | 24.5 | 54 | 36 | 248 | 14 |
| 1FN-16-12 | 1.7/16"X12UN | Z3/4"X14 | 17.5 | 19.5 | 51 | 41 | 291 | 17 |
| 1FN-16 | 1.7/16"X12UN | Z1"X11.5 | 17.5 | 24.5 | 55.5 | 41 | 305 | 14 |
| 1FN-16-20 | 1.7/16"X12UN | Z1.1/4"X11.5 | 17.5 | 25 | 58.5 | 46 | 420 | 8 |
| 1FN-20-16 | 1.11/16"X12UN | Z1"X11.5 | 17.5 | 24.5 | 57.5 | 46 | 372 | 14 |
| 1FN-20 | 1.11/16"X12UN | Z1.1/4"X11.5 | 17.5 | 25 | 58.5 | 46 | 425 | 8 |
| 1FN-24 | 2"X12UN | Z1.1/2"X11.5 | 17.5 | 26 | 61 | 55 | 595 | 7 |

1FN9

90°美制ORFS外螺纹O形圈平面密封/布锥管外螺纹
90°ORFS MALE O-RING/NPT MALE

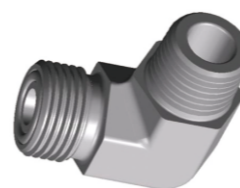
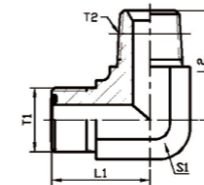

| 产品代号 PART NO. | 螺纹 THREAD | | 尺寸 DIMENSIONS | | | 重量 (g) | 压力等级 MPa |
|------------------|---------------|--------------|---------------|------|----|--------|-------------|
| | T1 | T2 | L1 | L2 | S1 | | |
| 1FN9-04-02 | 9/16"X18UNF | Z1/8"X27 | 21.5 | 20.5 | 14 | 33 | 34.5 |
| 1FN9-04 | 9/16"X18UNF | Z1/4"X18 | 21.5 | 25.5 | 14 | 43 | 27.5 |
| 1FN9-06-04 | 11/16"X16UN | Z1/4"X18 | 25 | 27.5 | 19 | 61 | |
| 1FN9-06 | 11/16"X16UN | Z3/8"X18 | 25 | 31 | 19 | 84 | 21 |
| 1FN9-06-08 | 11/16"X16UN | Z1/2"X14 | 29.5 | 37.5 | 22 | 112 | |
| 1FN9-08-06 | 13/16"X16UN | Z3/8"X18 | 28 | 31 | 19 | 95 | |
| 1FN9-08 | 13/16"X16UN | Z1/2"X14 | 31 | 37 | 22 | 114 | 17 |
| 1FN9-08-12 | 13/16"X16UN | Z3/4"X14 | 33.3 | 40.5 | 27 | 170 | |
| 1FN9-10-08 | 1"X14UNF | Z1/2"X14 | 33.5 | 40 | 27 | 172 | 21 |
| 1FN9-10-12 | 1"X14UNF | Z3/4"X14 | 36 | 40.5 | 27 | 216 | 17 |
| 1FN9-12-08 | 1.3/16"X12UN | Z1/2"X14 | 37.3 | 40.5 | 30 | 228 | 21 |
| 1FN9-12 | 1.3/16"X12UN | Z3/4"X14 | 37.3 | 45.5 | 30 | 275 | 17 |
| 1FN9-12-16 | 1.3/16"X12UN | Z1"X11.5 | 41 | 50 | 33 | 363 | 14 |
| 1FN9-16-12 | 1.7/16"X12UN | Z3/4"X14 | 42 | 46 | 36 | 360 | 17 |
| 1FN9-16 | 1.7/16"X12UN | Z1"X11.5 | 42 | 50.5 | 36 | 433 | 14 |
| 1FN9-20-16 | 1.11/16"X12UN | Z1"X11.5 | 45 | 54.5 | 41 | 530 | |
| 1FN9-20 | 1.11/16"X12UN | Z1.1/4"X11.5 | 45 | 60 | 41 | 574 | 8 |
| 1FN9-24 | 2"X12UN | Z1.1/2"X11.5 | 48.8 | 67 | 48 | 972 | 7 |

1FH

美制ORFS外螺纹O形圈平面密封/公制外螺纹重系列ISO 6149-2
ORFS MALE O-RING /METRIC MALE S-SERIES ISO 6149-2

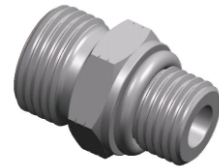
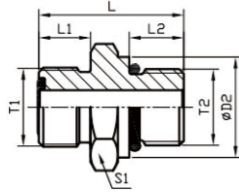

| 产品代号 PART NO. | 螺纹 THREAD | | 尺寸 DIMENSIONS | | | | 重量 (g) | 压力等级 MPa |
|------------------|----------------|---------|---------------|------|------|----|--------|-------------|
| | T1 | T2 | L1 | L2 | L | S1 | | |
| 1FH-04-12 | 9/16" X18UNF | M12X1.5 | 10 | 11 | 28.5 | 17 | 34 | 63 |
| 1FH-04-14 | 9/16" X18UNF | M14X1.5 | 10 | 11 | 29.5 | 19 | 44 | |
| 1FH-06-12 | 11/16" X16UN | M12X1.5 | 11 | 11 | 32 | 19 | 50 | |
| 1FH-06-14 | 11/16" X16UN | M14X1.5 | 11 | 11 | 32 | 19 | 53 | |
| 1FH-06-16 | 11/16" X16UN | M16X1.5 | 11 | 11.5 | 33.5 | 22 | 67 | |
| 1FH-06-18 | 11/16" X16UN | M18X1.5 | 11 | 12.5 | 36 | 24 | 86 | |
| 1FH-08-14 | 13/16" X16UN | M14X1.5 | 13 | 11 | 35 | 22 | 72 | |
| 1FH-08-16 | 13/16" X16UN | M16X1.5 | 13 | 11.5 | 36.5 | 24 | 85 | |
| 1FH-08-18 | 13/16" X16UN | M18X1.5 | 13 | 12.5 | 37 | 24 | 90 | |
| 1FH-08-22 | 13/16" X16UN | M22X1.5 | 13 | 13 | 39.5 | 27 | 118 | |
| 1FH-08-27 | 13/16" X16UN | M27X2 | 13 | 16 | 44 | 32 | 179 | |
| 1FH-10-18 | 1" X14UNF | M18X1.5 | 15.5 | 12.5 | 41 | 27 | 128 | |
| 1FH-10-22 | 1" X14UNF | M22X1.5 | 15.5 | 13 | 42 | 27 | 137 | |
| 1FH-10-27 | 1" X14UNF | M27X2 | 15.5 | 16.5 | 47 | 32 | 198 | |
| 1FH-12-22 | 1.3/16" X12UN | M22X1.5 | 17 | 13 | 45 | 32 | 195 | |
| 1FH-12-27 | 1.3/16" X12UN | M27X2 | 17 | 16 | 48.5 | 32 | 220 | |
| 1FH-12-33 | 1.3/16" X12UN | M33X2 | 17 | 16 | 51.5 | 41 | 343 | |
| 1FH-16-33 | 1.7/16" X12UN | M33X2 | 17.5 | 16 | 52 | 41 | 335 | |
| 1FH-20-42 | 1.11/16" X12UN | M42X2 | 17.5 | 16 | 54.5 | 50 | 502 | |
| 1FH-24-48 | 2" X12UN | M48X2 | 17.5 | 17.5 | 57 | 55 | 620 | |
| | | | | | | | | 25 |

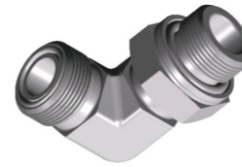
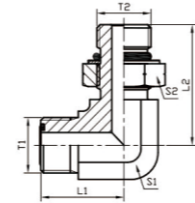

1FH9-OG

90°弯美制ORFS外螺纹O型圈平面密封/公制外螺纹可调向柱端轻系列ISO 6149
90°ELBOW ORFS MALE O-RING /METRIC MALE ADJUSTABLE STUD END L-SERIES ISO 6149

| 产品代号 PART NO. | 螺纹 THREAD | | 尺寸 DIMENSIONS | | | | 重量 (g) | 压力等级 MPa |
|------------------|----------------|---------|---------------|------|----|----|--------|-------------|
| | T1 | T2 | L1 | L2 | S1 | S2 | | |
| 1FH9-04-12OG | 9/16" X18UNF | M12X1.5 | 21.5 | 33 | 14 | 17 | 46 | 31.5 |
| 1FH9-04-14OG | 9/16" X18UNF | M14X1.5 | 24 | 35.5 | 17 | 19 | 60 | |
| 1FH9-06-12OG | 11/16" X16UN | M12X1.5 | 25 | 35.5 | 17 | 17 | 58 | |
| 1FH9-06-14OG | 11/16" X16UN | M14X1.5 | 25 | 35.5 | 17 | 19 | 69 | |
| 1FH9-06-16OG | 11/16" X16UN | M16X1.5 | 25 | 37.5 | 17 | 22 | 83 | |
| 1FH9-08-14OG | 13/16" X16UN | M14X1.5 | 28 | 36 | 19 | 19 | 88 | |
| 1FH9-08-18OG | 13/16" X16UN | M18X1.5 | 28 | 41 | 19 | 24 | 105 | 25 |
| 1FH9-08-22OG | 13/16" X16UN | M22X1.5 | 31 | 49 | 27 | 27 | 165 | |
| 1FH9-10-18OG | 1" X14UNF | M18X1.5 | 33.5 | 47.5 | 37 | 24 | 155 | |
| 1FH9-10-22OG | 1" X14UNF | M22X1.5 | 33.5 | 49 | 27 | 27 | 200 | |
| 1FH9-12-22OG | 1.3/16" X12UN | M22X1.5 | 37.5 | 49.5 | 27 | 27 | 250 | |
| 1FH9-12-27OG | 1.3/16" X12UN | M27X2 | 37.5 | 55.5 | 27 | 32 | 322 | |
| 1FH9-16-33OG | 1.7/16" X12UN | M33X2 | 41.5 | 59.5 | 36 | 41 | 500 | 16 |
| 1FH9-20-42OG | 1.11/16" X12UN | M42X2 | 44.5 | 63 | 41 | 50 | 667 | |
| 1FH9-24-48OG | 2" X12UN | M48X2 | 49 | 71.5 | 50 | 55 | 931 | |

1FM-WD

美制ORFS外螺纹O形圈平面密封/公制螺纹胶垫密封
ORFS MALE O-RING /METRIC THREAD MALE CAPTIVE SEAL

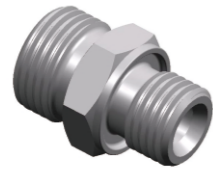
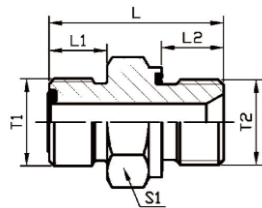

| 产品代号 PART NO. | 螺纹 THREAD | | 尺寸 DIMENSIONS | | | | 重量 (g) | 压力等级 MPa |
|------------------|----------------|---------|---------------|----|------|----|--------|-------------|
| | T1 | T2 | L1 | L2 | L | S1 | | |
| 1FM-04-12WD | 9/16" X18UNF | M12X1.5 | 10 | 12 | 29.7 | 17 | 36 | 63 |
| 1FM-06-14WD | 11/16" X16UN | M14X1.5 | 11 | 12 | 31.9 | 22 | 57 | |
| 1FM-06-16WD | 11/16" X16UN | M16X1.5 | 11 | 12 | 31.9 | 22 | 62 | |
| 1FM-08-18WD | 13/16" X16UN | M18X1.5 | 13 | 12 | 34.6 | 24 | 82 | |
| 1FM-10-22WD | 1" X14UNF | M22X1.5 | 15.5 | 14 | 41.1 | 27 | 131 | |
| 1FM-12-27WD | 1.3/16" X12UN | M27X2 | 17 | 16 | 46.1 | 32 | 206 | |
| 1FM-16-33WD | 1.7/16" X12UN | M33X2 | 17.5 | 18 | 49.8 | 41 | 313 | 42 |
| 1FM-20-42WD | 1.11/16" X12UN | M42X2 | 17.5 | 20 | 53.8 | 50 | 468 | |
| | | | | | | | | 25 |

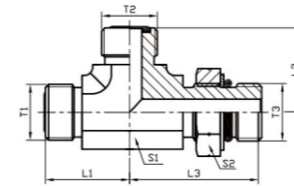

AFFH-OG

美制ORFS外螺纹O型圈平面密封/公制外螺纹可调向柱端重系列ISO 6149-2主支三通
ORFS MALE O-RING /METRIC MALE ADJUSTABLE STUD END S-SERIES ISO 6149-2 RUN TEE

| 产品代号 NO. | PART | 螺纹 THREAD | | | 尺寸 DIMENSIONS | | | | | 重量 (g) | 压力等级 MPa | |
|-----------------|------|----------------|----------------|---------|---------------|------|------|----|----|-----------|-------------|------|
| | | T1 | T2 | T3 | L1 | L2 | L3 | S1 | S2 | | | |
| AFFH-04-04-12OG | | 9/16" X18UNF | 9/16" X18UNF | M12X1.5 | 21.5 | 21.5 | 33 | 14 | 17 | 68 | 40 | |
| AFFH-04-04-14OG | | 9/16" X18UNF | 9/16" X18UNF | M14X1.5 | 24 | 24 | 35.5 | 19 | 19 | 86 | | |
| AFFH-06-06-14OG | | 11/16" X16UN | 11/16" X16UN | M14X1.5 | 25 | 25 | 35.5 | 19 | 19 | 110 | | |
| AFFH-06-06-16OG | | 11/16" X16UN | 11/16" X16UN | M16X1.5 | 25 | 25 | 37.5 | 19 | 22 | 120 | | |
| AFFH-08-08-14OG | | 13/16" X16UN | 13/16" X16UN | M14X1.5 | 28 | 28 | 36 | 19 | 19 | 125 | | |
| AFFH-08-08-18OG | | 13/16" X16UN | 13/16" X16UN | M18X1.5 | 28 | 28 | 41 | 19 | 24 | 158 | | |
| AFFH-08-08-22OG | | 13/16" X16UN | 13/16" X16UN | M22X1.5 | 31 | 31 | 49 | 27 | 27 | 222 | | |
| AFFH-10-10-22OG | | 1" X14UNF | 1" X14UNF | M22X1.5 | 33.5 | 33.5 | 49 | 27 | 27 | 293 | | |
| AFFH-12-12-27OG | | 1.3/16" X12UN | 1.3/16" X12UN | M27X2 | 37.5 | 37.5 | 55.5 | 32 | 32 | 465 | | |
| AFFH-16-16-33OG | | 1.7/16" X12UN | 1.7/16" X12UN | M33X2 | 41.5 | 41.5 | 59.5 | 41 | 41 | 657 | | 31.5 |
| AFFH-20-20-42OG | | 1.11/16" X12UN | 1.11/16" X12UN | M42X2 | 44.5 | 44.5 | 63 | 50 | 50 | 964 | | 25 |
| AFFH-24-24-48OG | | 2" X12UN | 2" X12UN | M48X2 | 49 | 49 | 71.5 | 55 | 55 | 1354 | | 20 |

1FB-WD

美制ORFS外螺纹O形圈平面密封/英管外螺纹胶垫密封
ORFS MALE O-RING/BSP MALE CAPTIVE SEAL

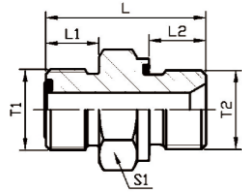

| 产品代号 PART NO. | 螺纹 THREAD | | 尺寸 DIMENSIONS | | | | 重量 (g) | 压力等级 MPa |
|------------------|---------------|------------|---------------|----|------|----|--------|-------------|
| | T1 | T2 | L1 | L2 | L | S1 | | |
| 1FB-04-02WD | 9/16"X18UNF | G1/8"X28 | 10 | 8 | 25.7 | 17 | 30 | 63 |
| 1FB-04WD | 9/16"X18UNF | G1/4"X19 | 10 | 12 | 30.9 | 19 | 44 | |
| 1FB-04-06WD | 9/16"X18UNF | G3/8"X19 | 10 | 12 | 31.6 | 22 | 60 | |
| 1FB-04-08WD | 9/16"X18UNF | G1/2"X14 | 10 | 14 | 38.4 | 27 | 110 | |
| 1FB-06-02WD | 11/16"X16UN | G1/8"X28 | 11 | 8 | 31.1 | 19 | 51 | |
| 1FB-06-04WD | 11/16"X16UN | G1/4"X19 | 11 | 12 | 31.9 | 19 | 50 | |
| 1FB-06WD | 11/16"X16UN | G3/8"X19 | 11 | 12 | 33.5 | 22 | 68 | |
| 1FB-06-08WD | 11/16"X16UN | G1/2"X14 | 11 | 14 | 38.5 | 27 | 110 | |
| 1FB-06-12WD | 11/16"X16UN | G3/4"X14 | 11 | 16 | 40.3 | 32 | 160 | |
| 1FB-08-04WD | 13/16"X16UN | G1/4"X19 | 13 | 12 | 36.7 | 22 | 73 | |
| 1FB-08-06WD | 13/16"X16UN | G3/8"X19 | 13 | 12 | 34.6 | 22 | 73 | |
| 1FB-08WD | 13/16"X16UN | G1/2"X14 | 13 | 14 | 40.1 | 27 | 115 | |
| 1FB-08-12WD | 13/16"X16UN | G3/4"X14 | 13 | 16 | 41.9 | 32 | 163 | |
| 1FB-10-06WD | 1" X14UNF | G3/8"X19 | 15.5 | 12 | 42.4 | 27 | 132 | |
| 1FB-10-08WD | 1" X14UNF | G1/2"X14 | 15.5 | 14 | 41.1 | 27 | 127 | |
| 1FB-10-12WD | 1" X14UNF | G3/4"X14 | 15.5 | 16 | 44.3 | 32 | 180 | |
| 1FB-10-16WD | 1" X14UNF | G1"X11 | 15.5 | 18 | 47.8 | 41 | 293 | |
| 1FB-12-08WD | 1.3/16"X12UN | G1/2"X14 | 17 | 14 | 48.5 | 32 | 200 | |
| 1FB-12WD | 1.3/16"X12UN | G3/4"X14 | 17 | 16 | 46.1 | 32 | 203 | |
| 1FB-12-16WD | 1.3/16"X12UN | G1"X11 | 17 | 18 | 47.5 | 41 | 295 | |
| 1FB-12-20WD | 1.3/16"X12UN | G1.1/4"X11 | 17 | 20 | 53.5 | 50 | 444 | |
| 1FB-16-12WD | 1.7/16"X12UN | G3/4"X14 | 17.5 | 16 | 50.3 | 41 | 285 | |
| 1FB-16WD | 1.7/16"X12UN | G1"X11 | 17.5 | 18 | 49.8 | 41 | 307 | |
| 1FB-16-20WD | 1.7/16"X12UN | G1.1/4"X11 | 17.5 | 20 | 53.8 | 50 | 459 | |
| 1FB-16-24WD | 1.7/16"X12UN | G1.1/2"X11 | 17.5 | 22 | 57.5 | 55 | 571 | |
| 1FB-20-16WD | 1.11/16"X12UN | G1"X11 | 17.5 | 18 | 57.3 | 46 | 472 | |
| 1FB-20WD | 1.11/16"X12UN | G1.1/4"X11 | 17.5 | 20 | 53.8 | 50 | 467 | |
| 1FB-20-24WD | 1.11/16"X12UN | G1.1/2"X11 | 17.5 | 22 | 57.6 | 55 | 578 | |
| 1FB-24WD | 2" X12UN | G1.1/2"X11 | 17.5 | 22 | 57.6 | 55 | 597 | |

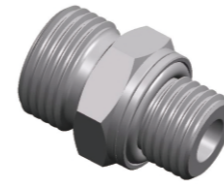
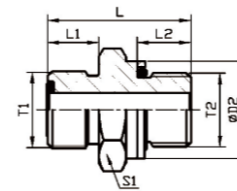

1FG

美制ORFS外螺纹O形圈平面密封/英管外螺纹O形圈密封
ORFS MALE O-RING/BSP MALE O-RING

| 产品代号 PART NO. | 螺纹 THREAD | | 尺寸 DIMENSIONS | | | | 重量 (g) | 压力等级 MPa |
|------------------|---------------|------------|---------------|----|------|----|--------|-------------|
| | T1 | T2 | L1 | L2 | L | S1 | | |
| 1FG-04-02 | 9/16"X18UNF | G1/8"X28 | 10 | 8 | 25.7 | 17 | 30 | 63 |
| 1FG-04 | 9/16"X18UNF | G1/4"X19 | 10 | 12 | 31 | 19 | 44 | |
| 1FG-04-06 | 9/16"X18UNF | G3/8"X19 | 10 | 12 | 31.5 | 22 | 60 | |
| 1FG-04-08 | 9/16"X18UNF | G1/2"X14 | 10 | 14 | 38.4 | 27 | 110 | |
| 1FG-06-02 | 11/16"X16UN | G1/8"X28 | 11 | 8 | 31 | 19 | 51 | |
| 1FG-06-04 | 11/16"X16UN | G1/4"X19 | 11 | 12 | 32 | 19 | 50 | |
| 1FG-06 | 11/16"X16UN | G3/8"X19 | 11 | 12 | 33.5 | 22 | 68 | |
| 1FG-06-08 | 11/16"X16UN | G1/2"X14 | 11 | 14 | 38.5 | 27 | 110 | |
| 1FG-06-12 | 11/16"X16UN | G3/4"X14 | 11 | 16 | 40 | 32 | 160 | |
| 1FG-08-04 | 13/16"X16UN | G1/4"X19 | 13 | 12 | 36.7 | 22 | 73 | |
| 1FG-08-06 | 13/16"X16UN | G3/8"X19 | 13 | 12 | 34.6 | 22 | 73 | |
| 1FG-08 | 13/16"X16UN | G1/2"X14 | 13 | 14 | 40 | 27 | 115 | |
| 1FG-08-12 | 13/16"X16UN | G3/4"X14 | 13 | 16 | 42 | 32 | 163 | |
| 1FG-10-06 | 1" X14UNF | G3/8"X19 | 15.5 | 12 | 42.4 | 27 | 132 | |
| 1FG-10-08 | 1" X14UNF | G1/2"X14 | 15.5 | 14 | 41 | 27 | 127 | |
| 1FG-10-12 | 1" X14UNF | G3/4"X14 | 15.5 | 16 | 44 | 32 | 180 | |
| 1FG-10-16 | 1" X14UNF | G1"X11 | 15.5 | 18 | 48 | 41 | 293 | |
| 1FG-12-08 | 1.3/16"X12UN | G1/2"X14 | 17 | 14 | 48.5 | 32 | 200 | |
| 1FG-12 | 1.3/16"X12UN | G3/4"X14 | 17 | 16 | 46 | 32 | 203 | |
| 1FG-12-16 | 1.3/16"X12UN | G1"X11 | 17 | 18 | 47.5 | 41 | 295 | |
| 1FG-12-20 | 1.3/16"X12UN | G1.1/4"X11 | 17 | 20 | 53.5 | 50 | 444 | |
| 1FG-16-12 | 1.7/16"X12UN | G3/4"X14 | 17.5 | 16 | 50.3 | 37 | 285 | |
| 1FG-16 | 1.7/16"X12UN | G1"X11 | 17.5 | 18 | 50 | 41 | 307 | |
| 1FG-16-20 | 1.7/16"X12UN | G1.1/4"X11 | 17.5 | 20 | 54 | 50 | 459 | |
| 1FG-16-24 | 1.7/16"X12UN | G1.1/2"X11 | 17.5 | 22 | 57.5 | 55 | 571 | |
| 1FG-20-16 | 1.11/16"X12UN | G1"X11 | 17.5 | 18 | 57.3 | 48 | 472 | |
| 1FG-20 | 1.11/16"X12UN | G1.1/4"X11 | 17.5 | 20 | 53.8 | 50 | 467 | |
| 1FG-20-24 | 1.11/16"X12UN | G1.1/2"X11 | 17.5 | 22 | 57.6 | 55 | 578 | |
| 1FG-24 | 2" X12UN | G1.1/2"X11 | 17.5 | 22 | 57.6 | 55 | 597 | |

AN

美制布锥管外螺纹三通
NPT MALE TEE

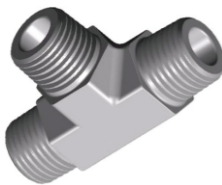
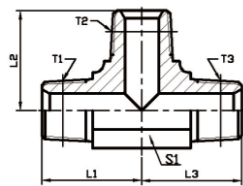

| 产品代号 PART NO. | 螺纹 THREAD | | | 尺寸 DIMENSIONS | | | | 重量 (g) | 压力等级 MPa |
|------------------|---------------|---------------|---------------|---------------|------|------|----|--------|-------------|
| | T1 | T2 | T3 | L1 | L2 | L3 | S1 | | |
| AN-02 | Z1/8" X27 | Z1/8" X27 | Z1/8" X27 | 21 | 21 | 21 | 11 | 32 | 34.5 |
| AN-04 | Z1/4" X18 | Z1/4" X18 | Z1/4" X18 | 25.5 | 25.5 | 25.5 | 14 | 58 | 27.5 |
| AN-06 | Z3/8" X18 | Z3/8" X18 | Z3/8" X18 | 31 | 31 | 31 | 19 | 112 | 21 |
| AN-08 | Z1/2" X14 | Z1/2" X14 | Z1/2" X14 | 36.7 | 36.7 | 36.7 | 22 | 193 | |
| AN-12 | Z3/4" X14 | Z3/4" X14 | Z3/4" X14 | 44 | 44 | 44 | 27 | 342 | 17 |
| AN-16 | Z1" X11.5 | Z1" X11.5 | Z1" X11.5 | 50 | 50 | 50 | 33 | 574 | 14 |
| AN-20 | Z1.1/4" X11.5 | Z1.1/4" X11.5 | Z1.1/4" X11.5 | 54.5 | 54.5 | 54.5 | 41 | 985 | 8 |
| AN-24 | Z1.1/2" X11.5 | Z1.1/2" X11.5 | Z1.1/2" X11.5 | 59.5 | 59.5 | 59.5 | 48 | 1344 | 7 |

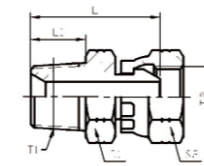

2NU

布锥管外螺纹/美制NPSM内螺纹60°外锥
NPT MALE/NPSM FEMALE 60° CONE

| 产品代号 PART NO. | 螺纹 THREAD | | 尺寸 DIMENSIONS | | | | 重量 (g) | 压力等级 MPa |
|------------------|---------------|------------------|---------------|------|----|----|--------|-------------|
| | T1 | T2 | L1 | L | S1 | S2 | | |
| 2NU-04 | Z1/4" X18 | 1/4" X18NPSM | 14.5 | 31.8 | 17 | 19 | 25 | 21 |
| 2NU-06 | Z3/8" X18 | 3/8" X18NPSM | 14.5 | 33.3 | 22 | 22 | 44 | |
| 2NU-08 | Z1/2" X14 | 1/2" X14NPSM | 19.5 | 41.1 | 27 | 27 | 75 | |
| 2NU-12 | Z3/4" X14 | 3/4" X14NPSM | 19.5 | 42.9 | 32 | 32 | 115 | 17 |
| 2NU-16 | Z1" X11.5 | 1" X11.5NPSM | 24.5 | 50.8 | 41 | 41 | 195 | 14 |
| 2NU-20 | Z1.1/4" X11.5 | 1.1/4" X11.5NPSM | 25 | 53.1 | 50 | 50 | 305 | 8 |
| 2NU-24 | Z1.1/2" X11.5 | 1.1/2" X11.5NPSM | 26 | 55.6 | 55 | 55 | 395 | 7 |

1FG9-OG

90°弯美制ORFS外螺纹O型圈平面密封/英管外螺纹O形圈
90°ELBOW ORFS MALE O-RING/BSP MALE O-RING

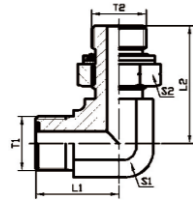

| 产品代号 PARTNO. | 螺纹 THREAD | | 尺寸 DIMENSIONS | | | | 重量 (g) | 压力等 级MPa |
|-----------------|---------------|------------|---------------|------|----|----|-----------|-------------|
| | T1 | T2 | L1 | L2 | S1 | S2 | | |
| 1FG9-04-02OG | 9/16"X18UNF | G1/8"X28 | 21.5 | 30 | 14 | 14 | 35 | 31.5 |
| 1FG9-04OG | 9/16"X18UNF | G1/4"X19 | 23.5 | 36 | 19 | 19 | 56 | |
| 1FG9-04-06OG | 9/16"X18UNF | G3/8"X19 | 24.5 | 38 | 19 | 22 | 76 | 25 |
| 1FG9-06-04OG | 11/16"X16UN | G1/4"X19 | 25 | 36 | 19 | 19 | 65 | 31.5 |
| 1FG9-06OG | 11/16"X16UN | G3/8"X19 | 26.5 | 38 | 19 | 22 | 90 | 25 |
| 1FG9-08-04OG | 13/16"X16UN | G1/4"X19 | 28 | 35.5 | 19 | 19 | 80 | 31.5 |
| 1FG9-08-06OG | 13/16"X16UN | G3/8"X19 | 28 | 38 | 19 | 22 | 103 | 25 |
| 1FG9-08OG | 13/16"X16UN | G1/2"X14 | 31 | 48.5 | 27 | 27 | 151 | |
| 1FG9-08-12OG | 13/16"X16UN | G3/4"X14 | 33.5 | 51.5 | 30 | 36 | 221 | 16 |
| 1FG9-10-06OG | 1"X14UNF | G3/8"X19 | 33.5 | 40.5 | 27 | 22 | 147 | 25 |
| 1FG9-10-08OG | 1"X14UNF | G1/2"X14 | 33.5 | 48.5 | 27 | 27 | 187 | |
| 1FG9-10-12OG | 1"X14UNF | G3/4"X14 | 36 | 51.5 | 30 | 36 | 258 | 16 |
| 1FG9-10-16OG | 1"X14UNF | G1"X11 | 39.5 | 58.5 | 36 | 41 | 395 | |
| 1FG9-12-08OG | 1.3/16"X12UN | G1/2"X14 | 37.5 | 49.5 | 30 | 27 | 238 | 25 |
| 1FG9-12OG | 1.3/16"X12UN | G3/4"X14 | 37.5 | 51.5 | 30 | 36 | 301 | 16 |
| 1FG9-12-16OG | 1.3/16"X12UN | G1"X11 | 41 | 48.5 | 36 | 41 | 392 | |
| 1FG9-16-12OG | 1.7/16"X12UN | G3/4"X14 | 41.5 | 56 | 36 | 36 | 362 | 16 |
| 1FG9-16OG | 1.7/16"X12UN | G1"X11 | 41.5 | 58.5 | 36 | 41 | 237 | |
| 1FG9-16-20OG | 1.7/16"X12UN | G1.1/4"X11 | 44.5 | 61 | 41 | 50 | 596 | 16 |
| 1FG9-20-16OG | 1.11/16"X12UN | G1"X11 | 44.5 | 61 | 41 | 41 | 525 | |
| 1FG9-20OG | 1.11/16"X12UN | G1.1/4"X11 | 44.5 | 61 | 41 | 50 | 652 | 16 |
| 1FG9-20-24OG | 1.11/16"X12UN | G1.1/2"X11 | 49 | 64.5 | 50 | 55 | 767 | |
| 1FG9-24OG | 2" X12UN | G1.1/2"X11 | 49 | 64.5 | 50 | 55 | 875 | 16 |

AFFG-OG

美制ORFS外螺纹O型圈平面密封/英管外螺纹O形圈主支三通
ORFS MALE O-RING/BSP MALE O-RING RUN TEE

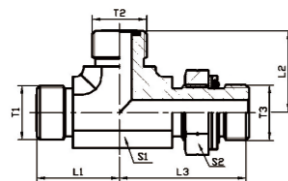

| 产品代号 PART NO. | 螺纹 THREAD | | | 尺寸 DIMENSIONS | | | | | 重量 (g) | 压力等 级MPa |
|------------------|--------------|--------------|----------|---------------|------|------|----|----|-----------|-------------|
| | T1 | T2 | T3 | L1 | L2 | L3 | S1 | S2 | | |
| AFFG-04-04-02OG | 9/16"X18UNF | 9/16"X18UNF | G1/8"X28 | 21.5 | 21.5 | 30 | 14 | 14 | 58 | 31.5 |
| AFFG-04OG | 9/16"X18UNF | 9/16"X18UNF | G1/4"X19 | 23.5 | 23.5 | 36 | 19 | 19 | 80 | |
| AFFG-06-06-04OG | 11/16"X16UN | 11/16"X16UN | G1/4"X19 | 25 | 25 | 36 | 19 | 19 | 106 | 25 |
| AFFG-06OG | 11/16"X16UN | 11/16"X16UN | G3/8"X19 | 26.5 | 26.5 | 38 | 19 | 22 | 130 | |
| AFFG-08-08-06OG | 13/16"X16UN | 13/16"X16UN | G3/8"X19 | 28 | 28 | 38 | 19 | 22 | 144 | 25 |
| AFFG-08OG | 13/16"X16UN | 13/16"X16UN | G1/2"X14 | 31 | 31 | 48.5 | 27 | 27 | 210 | |
| AFFG-10-10-08OG | 1"X14UNF | 1"X14UNF | G1/2"X14 | 33.5 | 33.5 | 48.5 | 27 | 27 | 280 | 16 |
| AFFG-10-10-12OG | 1"X14UNF | 1"X14UNF | G3/4"X14 | 36 | 36 | 51.5 | 30 | 36 | 359 | |
| AFFG-12OG | 1.3/16"X12UN | 1.3/16"X12UN | G3/4"X14 | 37.5 | 37.5 | 51.5 | 30 | 36 | 444 | 16 |
| AFFG-12-12-16OG | 1.3/16"X12UN | 1.3/16"X12UN | G1"X11 | 41 | 41 | 58.5 | 37 | 41 | 597 | |
| AFFG-16OG | 1.7/16"X12UN | 1.7/16"X12UN | G1"X11 | 41.5 | 41.5 | 58.5 | 37 | 41 | 715 | 16 |

1N

美制布锥管外螺纹
NPT MALE

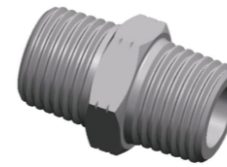
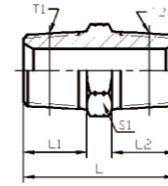

| 产品代号 PART NO. | 螺纹 THREAD | | 尺寸 DIMENSIONS | | | | 重量 (g) | 压力等 级MPa |
|------------------|--------------|--------------|---------------|------|------|----|--------|-------------|
| | T1 | T2 | L1 | L2 | L | S1 | | |
| 1N-02 | Z1/8"X27 | Z1/8"X27 | 10.5 | 10.5 | 27 | 12 | 15 | 34.5 |
| 1N-02-04 | Z1/8"X27 | Z1/4"X18 | 10.5 | 15 | 31 | 17 | 27 | 27.5 |
| 1N-02-06 | Z1/8"X27 | Z3/8"X18 | 10.5 | 16 | 32 | 19 | 40 | 21 |
| 1N-04 | Z1/4"X18 | Z1/4"X18 | 15 | 15 | 37 | 17 | 31 | 27.5 |
| 1N-04-06 | Z1/4"X18 | Z3/8"X18 | 15 | 16 | 37 | 19 | 42 | 21 |
| 1N-04-08 | Z1/4"X18 | Z1/2"X14 | 15 | 19.5 | 41.5 | 22 | 70 | |
| 1N-06 | Z3/8"X18 | Z3/8"X18 | 16 | 16 | 38 | 19 | 45 | 17 |
| 1N-06-08 | Z3/8"X18 | Z1/2"X14 | 16 | 19.5 | 43.5 | 22 | 75 | |
| 1N-06-12 | Z3/8"X18 | Z3/4"X14 | 16 | 19.5 | 45.5 | 27 | 122 | 17 |
| 1N-08 | Z1/2"X14 | Z1/2"X14 | 19.5 | 19.5 | 48 | 22 | 81 | 21 |
| 1N-08-12 | Z1/2"X14 | Z3/4"X14 | 19.5 | 19.5 | 49 | 27 | 125 | 17 |
| 1N-08-16 | Z1/2"X14 | Z1" X11.5 | 19.5 | 25.5 | 56 | 36 | 239 | 14 |
| 1N-12 | Z3/4"X14 | Z3/4"X14 | 19.5 | 19.5 | 49.8 | 30 | 135 | 17 |
| 1N-12-16 | Z3/4"X14 | Z1" X11.5 | 19.5 | 25.5 | 55 | 36 | 225 | |
| 1N-12-20 | Z3/4"X14 | Z1.1/4"X11.5 | 19.5 | 26.5 | 59 | 46 | 408 | 8 |
| 1N-16 | Z1"X11.5 | Z1" X11.5 | 25.5 | 25.5 | 59.5 | 36 | 222 | 8 |
| 1N-16-20 | Z1"X11.5 | Z1.1/4"X11.5 | 25.5 | 26.5 | 64 | 46 | 400 | |
| 1N-16-24 | Z1"X11.5 | Z1.1/2"X11.5 | 25.5 | 27.5 | 68 | 50 | 556 | 7 |
| 1N-20 | Z1.1/4"X11.5 | Z1.1/4"X11.5 | 26.5 | 26.5 | 63 | 46 | 376 | 8 |
| 1N-20-24 | Z1.1/4"X11.5 | Z1.1/2"X11.5 | 26.5 | 27.5 | 69 | 50 | 544 | |
| 1N-24 | Z1.1/2"X11.5 | Z1.1/2"X11.5 | 27.5 | 27.5 | 66.5 | 50 | 592 | 7 |
| 1N-24-32 | Z1.1/2"X11.5 | Z2" X11.5 | 26.5 | 27.5 | 72 | 65 | 925 | |
| 1N-32 | Z2"X11.5 | Z2" X11.5 | 27.5 | 27.5 | 71.5 | 65 | 735 | 7 |

1N9

90°弯美制布锥管外螺纹90° ELBOW NPT MALE

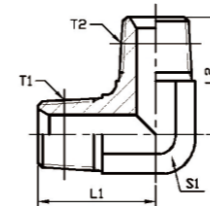

| 产品代号 PART NO. | 螺纹 THREAD | | 尺寸 DIMENSIONS | | | 重量 (g) | 压力等 级MPa |
|------------------|--------------|--------------|---------------|------|----|--------|-------------|
| | T1 | T2 | L1 | L2 | S1 | | |
| 1N9-02 | Z1/8"X27 | Z1/8"X27 | 21 | 21 | 11 | 21 | 34.5 |
| 1N9-02-04 | Z1/8"X27 | Z1/4"X18 | 23.5 | 25.5 | 14 | 31 | 27.5 |
| 1N9-04 | Z1/4"X18 | Z1/4"X18 | 25.5 | 25.5 | 14 | 39 | |
| 1N9-04-06 | Z1/4"X18 | Z3/8"X18 | 28 | 31 | 19 | 58 | 21 |
| 1N9-04-08 | Z1/4"X18 | Z1/2"X14 | 30.5 | 36.5 | 22 | 86 | |
| 1N9-06 | Z3/8"X18 | Z3/8"X18 | 31 | 31 | 19 | 75 | 17 |
| 1N9-06-08 | Z3/8"X18 | Z1/2"X14 | 33.8 | 37.3 | 22 | 106 | |
| 1N9-08 | Z1/2"X14 | Z1/2"X14 | 37.3 | 37.3 | 22 | 130 | 17 |
| 1N9-08-12 | Z1/2"X14 | Z3/4"X14 | 40 | 44 | 27 | 184 | |
| 1N9-12 | Z3/4"X14 | Z3/4"X14 | 44 | 44 | 27 | 228 | 14 |
| 1N9-12-16 | Z3/4"X14 | Z1"X11.5 | 46.5 | 50 | 33 | 311 | |
| 1N9-16 | Z1"X11.5 | Z1"X11.5 | 50 | 50 | 33 | 382 | 8 |
| 1N9-20 | Z1.1/4"X11.5 | Z1.1/4"X11.5 | 54 | 54 | 41 | 650 | |
| 1N9-24 | Z1.1/2"X11.5 | Z1.1/2"X11.5 | 63 | 63 | 48 | 948 | 7 |
| 1N9-32 | Z2"X11.5 | Z2"X11.5 | 68 | 68 | 63 | 1335 | |

2NU9

90°弯布锥管外螺纹/美制NPSM内螺纹60°外锥
90° ELBOW NPT MALE/NPSM FEMALE 60° CONE

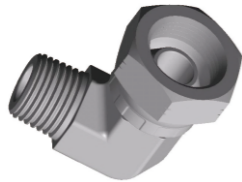
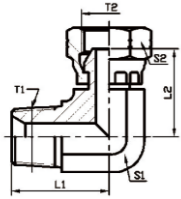

| 产品代号 PART NO. | 螺纹 THREAD | | 尺寸 DIMENSIONS | | | | 重量 (g) | 压力等级 MPa |
|------------------|--------------|-----------------|---------------|------|----|----|--------|-------------|
| | T1 | T2 | L1 | L2 | S1 | S2 | | |
| 2NU9-04 | Z1/4"X18 | 1/4"X18NPSM | 27.7 | 22.4 | 14 | 19 | 37 | 27.5 |
| 2NU9-06 | Z3/8"X18 | 3/8"X18NPSM | 31 | 25.1 | 19 | 22 | 65 | 21 |
| 2NU9-08 | Z1/2"X14 | 1/2"X14NPSM | 37.4 | 28.2 | 22 | 27 | 110 | |
| 2NU9-12 | Z3/4"X14 | 3/4"X14NPSM | 40.4 | 33 | 27 | 32 | 181 | 17 |
| 2NU9-16 | Z1"X11.5 | 1"X11.5NPSM | 50 | 39.1 | 33 | 41 | 325 | 14 |
| 2NU9-20 | Z1.1/4"X11.5 | 1.1/4"X11.5NPSM | 60.5 | 44 | 41 | 50 | 600 | 7 |
| 2NU9-24 | Z1.1/2"X11.5 | 1.1/2"X11.5NPSM | 67 | 48 | 48 | 55 | 824 | |
| 2NU9-32 | Z2"X11.5 | 2"X11.5NPSM | 76.2 | 57.7 | 63 | 70 | 1249 | |

4N

美制布锥管外螺纹堵头
NPT MALE PLUG

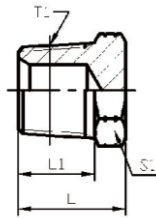

| 产品代号 PART NO. | 螺纹 THREAD | 尺寸 DIMENSIONS | | | 重量 (g) | 压力等级 MPa |
|------------------|--------------|---------------|------|----|--------|-------------|
| | T1 | L1 | L | S1 | | |
| 4N-02 | Z1/8"X27 | 10.5 | 16 | 12 | 10 | 34.5 |
| 4N-04 | Z1/4"X18 | 15 | 20 | 17 | 20 | 27.5 |
| 4N-06 | Z3/8"X18 | 16 | 21 | 19 | 30 | 21 |
| 4N-08 | Z1/2"X14 | 19.5 | 27 | 22 | 56 | |
| 4N-12 | Z3/4"X14 | 19.5 | 29.5 | 27 | 95 | 17 |
| 4N-16 | Z1"X11.5 | 25.5 | 36.5 | 36 | 185 | 14 |
| 4N-20 | Z1.1/4"X11.5 | 26.5 | 38.5 | 46 | 315 | 8 |
| 4N-24 | Z1.1/2"X11.5 | 27.5 | 43 | 50 | 444 | 7 |
| 4N-32 | Z2"X11.5 | 27.5 | 43.5 | 65 | 686 | |

GN

美制布锥管内螺纹三通
NPT FEMALE TEE

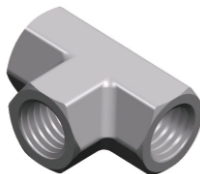
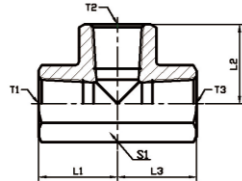

| 产品代号 PART NO. | 螺纹 THREAD | | | 尺寸 DIMENSIONS | | | | 重量 (g) | 压力等级 MPa |
|------------------|--------------|--------------|--------------|---------------|------|------|----|--------|-------------|
| | T1 | T2 | T3 | L1 | L2 | L3 | S1 | | |
| GN-02PK | Z1/8"X27 | Z1/8"X27 | Z1/8"X27 | 20 | 20 | 20 | 16 | 48 | 34.5 |
| GN-04PK | Z1/4"X18 | Z1/4"X18 | Z1/4"X18 | 22.5 | 22.5 | 22.5 | 19 | 61 | 21 |
| GN-06PK | Z3/8"X18 | Z3/8"X18 | Z3/8"X18 | 26 | 26 | 26 | 24 | 112 | |
| GN-08PK | Z1/2"X14 | Z1/2"X14 | Z1/2"X14 | 31 | 31 | 31 | 27 | 133 | 17 |
| GN-12PK | Z3/4"X14 | Z3/4"X14 | Z3/4"X14 | 34 | 34 | 34 | 33 | 194 | |
| GN-16PK | Z1"X11.5 | Z1"X11.5 | Z1"X11.5 | 42 | 42 | 42 | 41 | 365 | 14 |
| GN-20PK | Z1.1/4"X11.5 | Z1.1/4"X11.5 | Z1.1/4"X11.5 | 48 | 48 | 48 | 50 | 530 | 8 |
| GN-24PK | Z1.1/2"X11.5 | Z1.1/2"X11.5 | Z1.1/2"X11.5 | 53 | 53 | 53 | 60 | 1027 | 7 |
| GN-32PK | Z2"X11.5 | Z2"X11.5 | Z2"X11.5 | 62 | 62 | 62 | 70 | 1202 | |

5N

美制布锥管螺纹/布锥管内螺纹
NPT MALE/NPT FEMALE

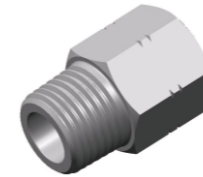
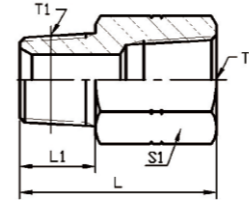

| 产品代号 PART NO. | 螺纹 THREAD | | 尺寸 DIMENSIONS | | | 重量 (g) | 压力等级 MPa |
|------------------|--------------|--------------|---------------|------|----|--------|-------------|
| | T1 | T2 | L1 | L | S1 | | |
| 5N-02 | Z1/8"X27 | Z1/8"X27 | 10.5 | 26.4 | 17 | 25 | 34.5 |
| 5N-04-02 | Z1/4"X18 | Z1/4"X27 | 15 | 22 | 17 | 36 | 27.5 |
| 5N-04 | Z1/4"X18 | Z1/4"X18 | 15 | 35.3 | 19 | 38 | |
| 5N-04-06 | Z1/4"X18 | Z3/8"X18 | 15 | 37 | 24 | 58 | 21 |
| 5N-06-04 | Z3/8"X18 | Z1/4"X18 | 16 | 22 | 19 | 28 | |
| 5N-06 | Z3/8"X18 | Z3/8"X18 | 16 | 37 | 24 | 63 | 17 |
| 5N-06-08 | Z3/8"X18 | Z1/2"X14 | 16 | 43 | 30 | 112 | |
| 5N-08-06 | Z1/2"X14 | Z3/8"X18 | 19.5 | 28.5 | 24 | 54 | 14 |
| 5N-08 | Z1/2"X14 | Z1/2"X14 | 19.5 | 47.5 | 30 | 124 | |
| 5N-08-12 | Z1/2"X14 | Z3/4"X14 | 19.5 | 49 | 36 | 160 | 8 |
| 5N-12-08 | Z3/4"X14 | Z1/2"X14 | 19.5 | 30 | 27 | 72 | |
| 5N-12 | Z3/4"X14 | Z3/4"X14 | 25.5 | 49 | 36 | 165 | 7 |
| 5N-16-12 | Z1"X11.5 | Z3/4"X14 | 25 | 34.5 | 36 | 139 | |
| 5N-16 | Z1"X11.5 | Z1"X11.5 | 25 | 60.5 | 41 | 269 | 14 |
| 5N-16-20 | Z1"X11.5 | Z1.1/4"X11.5 | 25.5 | 62.5 | 50 | 351 | |
| 5N-20-16 | Z1.1/4"X11.5 | Z1"X11.5 | 25.5 | 37.5 | 46 | 236 | 8 |
| 5N-20 | Z1.1/4"X11.5 | Z1.1/4"X11.5 | 25.5 | 63.5 | 50 | 396 | |
| 5N-20-24 | Z1.1/4"X11.5 | Z1.1/2"X11.5 | 25.5 | 63.5 | 60 | 559 | 7 |
| 5N-24-20 | Z1.1/2"X11.5 | Z1.1/4"X11.5 | 26.5 | 40 | 50 | 311 | |
| 5N-24 | Z1.1/2"X11.5 | Z1.1/2"X11.5 | 26.5 | 64.5 | 65 | 727 | 7 |
| 5N-24-32 | Z1.1/2"X11.5 | Z2"X11.5 | 26.5 | 67 | 70 | 673 | |
| 5N-32-24 | Z2"X11.5 | Z1.1/2"X11.5 | 27.5 | 44.5 | 65 | 605 | 7 |
| 5N-32 | Z2"X11.5 | Z2"X11.5 | 27.5 | 67.6 | 70 | 728 | |

5N9

90°弯美制布锥管外螺纹/布锥管内螺纹
90° ELBOW NPT MALE/NPT FEMALE

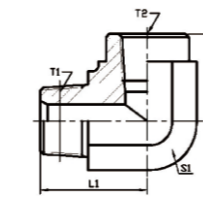

| 产品代号 PART NO. | 螺纹 THREAD | | 尺寸 DIMENSIONS | | | 重量 (g) | 压力等级 MPa |
|------------------|--------------|--------------|---------------|------|----|--------|-------------|
| | T1 | T2 | L1 | L2 | S1 | | |
| 5N9-02 | Z1/8"X27 | Z1/8"X27 | 24.5 | 17.8 | 16 | 25 | 34.5 |
| 5N9-04 | Z1/4"X18 | Z1/4"X18 | 28 | 22.4 | 19 | 40 | 27.5 |
| 5N9-04-06 | Z1/4"X18 | Z3/8"X18 | 31 | 25 | 24 | 60 | 21 |
| 5N9-06 | Z3/8"X18 | Z3/8"X18 | 33.5 | 25 | 24 | 74 | |
| 5N9-08 | Z1/2"X14 | Z1/2"X14 | 41.2 | 31.2 | 30 | 138 | 17 |
| 5N9-12-08 | Z3/4"X14 | Z1/2"X14 | 45 | 31.2 | 30 | 176 | |
| 5N9-12 | Z3/4"X14 | Z3/4"X14 | 45.2 | 34.5 | 33 | 174 | 14 |
| 5N9-16 | Z1"X11.5 | Z1"X11.5 | 54.5 | 41.1 | 41 | 310 | |
| 5N9-20 | Z1.1/4"X11.5 | Z1.1/4"X11.5 | 63 | 43.2 | 48 | 458 | 8 |
| 5N9-24 | Z1.1/2"X11.5 | Z1.1/2"X11.5 | 71.5 | 52.8 | 63 | 935 | 7 |
| 5N9-32 | Z2"X11.5 | Z2"X11.5 | 73.5 | 62 | 65 | 840 | |

7N

美制布锥管内螺纹
NPT FEMALE

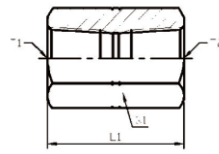

| 产品代号 PART NO. | 螺纹 THREAD | | 尺寸 DIMENSIONS | | 重量 (g) | 压力等级 MPa |
|------------------|--------------|--------------|---------------|----|--------|-------------|
| | T1 | T2 | L1 | S1 | | |
| 7N-02 | Z1/8"X27 | Z1/8"X27 | 24 | 17 | 28 | 34.5 |
| 7N-02-04 | Z1/8"X27 | Z1/4"X18 | 27 | 19 | 38 | 27.5 |
| 7N-02-06 | Z1/8"X27 | Z3/8"X18 | 30 | 22 | 55 | 21 |
| 7N-04 | Z1/4"X18 | Z1/4"X18 | 29 | 19 | 33 | |
| 7N-04-06 | Z1/4"X18 | Z3/8"X18 | 31 | 22 | 49 | |
| 7N-04-08 | Z1/4"X18 | Z1/2"X14 | 35 | 30 | 129 | |
| 7N-06 | Z3/8"X18 | Z3/8"X18 | 29 | 22 | 37 | 17 |
| 7N-06-08 | Z3/8"X18 | Z1/2"X14 | 38 | 30 | 128 | |
| 7N-06-12 | Z3/8"X18 | Z3/4"X14 | 40 | 36 | 201 | 21 |
| 7N-08 | Z1/2"X14 | Z1/2"X14 | 38 | 30 | 110 | |
| 7N-08-12 | Z1/2"X14 | Z3/4"X14 | 43 | 36 | 197 | 17 |
| 7N-12 | Z3/4"X14 | Z3/4"X14 | 39 | 36 | 148 | |
| 7N-12-16 | Z3/4"X14 | Z1"X11.5 | 45.5 | 41 | 227 | 14 |
| 7N-16 | Z1"X11.5 | Z1"X11.5 | 48 | 41 | 183 | |
| 7N-20 | Z1.1/4"X11.5 | Z1.1/4"X11.5 | 49 | 50 | 239 | 8 |
| 7N-24 | Z1.1/2"X11.5 | Z1.1/2"X11.5 | 49 | 60 | 409 | 7 |
| 7N-32 | Z2"X11.5 | Z2"X11.5 | 50 | 70 | 422 | |

7N9

90°美制布锥管内螺纹
90°NPT FEMALE

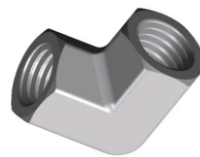
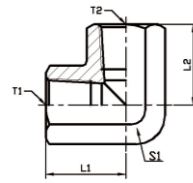

| 产品代号 PART NO. | 螺纹 THREAD | | 尺寸 DIMENSIONS | | | 重量 (g) | 压力等级 MPa |
|------------------|--------------|--------------|---------------|------|----|--------|-------------|
| | T1 | T2 | L1 | L2 | S1 | | |
| 7N9-02 | Z1/8"X27 | Z1/8"X27 | 20 | 20 | 16 | 38 | 34.5 |
| 7N9-04 | Z1/4"X18 | Z1/4"X18 | 22.5 | 22.5 | 19 | 51 | 21 |
| 7N9-06 | Z3/8"X18 | Z3/8"X18 | 26 | 26 | 24 | 96 | |
| 7N9-08 | Z1/2"X14 | Z1/2"X14 | 31 | 31 | 27 | 114 | 21 |
| 7N9-12 | Z3/4"X14 | Z3/4"X14 | 34 | 34 | 33 | 173 | 17 |
| 7N9-16 | Z1"X11.5 | Z1"X11.5 | 42 | 42 | 41 | 320 | 14 |
| 7N9-20 | Z1.1/4"X11.5 | Z1.1/4"X11.5 | 48 | 48 | 50 | 469 | 8 |
| 7N9-24 | Z1.1/2"X11.5 | Z1.1/2"X11.5 | 53 | 53 | 60 | 885 | 7 |
| 7N9-32 | Z2"X11.5 | Z2"X11.5 | 62 | 62 | 70 | 1048 | |

1J4

45°美制JIC外螺纹74°外锥
45°JIC MALE 74° CONE

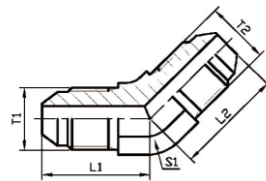

| 产品代号 PART NO. | 螺纹 THREAD | | 尺寸 DIMENSIONS | | | 重量 (g) | 压力等级 MPa |
|------------------|--------------|--------------|---------------|------|----|--------|-------------|
| | T1 | T2 | L1 | L2 | S1 | | |
| 1J4-04 | 7/16"X20UNF | 7/16"X20UNF | 21.5 | 21.5 | 11 | 25 | 34.5 |
| 1J4-05 | 1/2"X20UNF | 1/2"X20UNF | 23 | 23 | 14 | 33 | |
| 1J4-06 | 9/16"X18UNF | 9/16"X18UNF | 22.8 | 22.8 | 14 | 39 | |
| 1J4-08 | 3/4"X16UNF | 3/4"X16UNF | 26.8 | 26.8 | 19 | 83 | 31 |
| 1J4-10 | 7/8"X14UNF | 7/8"X14UNF | 31 | 31 | 22 | 120 | 24 |
| 1J4-12 | 1.1/16"X12UN | 1.1/16"X12UN | 35.5 | 35.5 | 27 | 198 | |
| 1J4-16 | 1.5/16"X12UN | 1.5/16"X12UN | 37.3 | 37.3 | 33 | 295 | 21 |

1J

美制JIC外螺纹74°外锥
JIC MALE 74° CONE

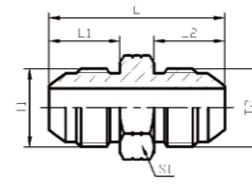

| 产品代号 PART NO. | 螺纹 THREAD | | 尺寸 DIMENSIONS | | | | 重量 (g) | 压力等级 MPa |
|------------------|---------------|---------------|---------------|------|------|----|--------|-------------|
| | T1 | T2 | L1 | L2 | L | S1 | | |
| 1J-04 | 7/16"X20UNF | 7/16"X20UNF | 14 | 14 | 34 | 12 | 23 | 34.5 |
| 1J-04-05 | 7/16"X20UNF | 1/2"X20UNF | 14 | 14 | 34 | 14 | 26 | |
| 1J-04-06 | 7/16"X20UNF | 9/16"X18UNF | 14 | 14.1 | 36 | 17 | 35 | |
| 1J-04-08 | 7/16"X20UNF | 3/4"X16UNF | 14 | 16.7 | 38.5 | 22 | 60 | 31 |
| 1J-05 | 1/2"X20UNF | 1/2"X20UNF | 14 | 14 | 34.8 | 14 | 29 | 34.5 |
| 1J-05-06 | 1/2"X20UNF | 9/16"X18UNF | 14 | 14.1 | 34 | 17 | 35 | |
| 1J-05-08 | 1/2"X20UNF | 3/4"X16UNF | 14 | 16.7 | 38.5 | 22 | 63 | 31 |
| 1J-06 | 9/16"X18UNF | 9/16"X18UNF | 14.1 | 14.1 | 34.2 | 17 | 35 | 34.5 |
| 1J-06-08 | 9/16"X18UNF | 3/4"X16UNF | 14.1 | 16.7 | 38.5 | 22 | 62 | 31 |
| 1J-06-10 | 9/16"X18UNF | 7/8"X14UNF | 14.1 | 19.3 | 41.5 | 24 | 81 | 24 |
| 1J-08 | 3/4"X16UNF | 3/4"X16UNF | 16.7 | 16.7 | 42 | 22 | 78 | 31 |
| 1J-08-10 | 3/4"X16UNF | 7/8"X14UNF | 16.7 | 19.3 | 44 | 24 | 92 | 24 |
| 1J-08-12 | 3/4"X16UNF | 1.1/16"X12UN | 16.7 | 21.9 | 49 | 30 | 148 | |
| 1J-10 | 7/8"X14UNF | 7/8"X14UNF | 19.3 | 19.3 | 46.5 | 24 | 102 | 21 |
| 1J-10-12 | 7/8"X14UNF | 1.1/16"X12UN | 19.3 | 21.9 | 51 | 30 | 152 | |
| 1J-10-16 | 7/8"X14UNF | 1.5/16"X12UN | 19.3 | 23.1 | 53.5 | 36 | 219 | 17 |
| 1J-12 | 1.1/16"X12UN | 1.1/16"X12UN | 21.9 | 21.9 | 54 | 30 | 175 | |
| 1J-12-14 | 1.1/16"X12UN | 1.3/16"X12UN | 21.9 | 22.6 | 55.5 | 32 | 203 | 10.5 |
| 1J-12-16 | 1.1/16"X12UN | 1.5/16"X12UN | 21.9 | 23.1 | 56.1 | 36 | 236 | |
| 1J-14 | 1.3/16"X12UN | 1.3/16"X12UN | 22.6 | 22.6 | 56.1 | 32 | 239 | 10.5 |
| 1J-14-16 | 1.3/16"X12UN | 1.5/16"X12UN | 22.6 | 23.1 | 56.5 | 36 | 260 | |
| 1J-16 | 1.5/16"X12UN | 1.5/16"X12UN | 23.1 | 23.1 | 57 | 36 | 257 | 17 |
| 1J-16-20 | 1.5/16"X12UN | 1.5/8"X12UN | 23.1 | 24.3 | 60.5 | 46 | 384 | |
| 1J-16-24 | 1.5/16"X12UN | 1.7/8"X12UN | 23.1 | 27.5 | 65.5 | 50 | 497 | 14 |
| 1J-20 | 1.5/8"X12UN | 1.5/8"X12UN | 24.3 | 24.3 | 62 | 46 | 422 | 17 |
| 1J-20-24 | 1.5/8"X12UN | 1.7/8"X12UN | 24.3 | 27.5 | 67 | 50 | 523 | 14 |
| 1J-20-32 | 1.5/8"X12UN | 2.1/2"X12UNUN | 24.3 | 33.9 | 75 | 65 | 978 | 10.5 |
| 1J-24 | 1.7/8"X12UN | 1.7/8"X12UN | 27.5 | 27.5 | 70 | 50 | 553 | 14 |
| 1J-24-32 | 1.7/8"X12UN | 2.1/2"X12UNUN | 27.5 | 33.9 | 78.5 | 65 | 896 | 10.5 |
| 1J-32 | 2.1/2"X12UNUN | 2.1/2"X12UNUN | 33.9 | 33.9 | 85 | 65 | 1150 | |

1J9

90°美制JIC外螺纹74°外锥
90°JIC MALE 74° CONE

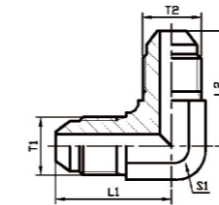

| 产品代号 PART NO. | 螺纹 THREAD | | 尺寸 DIMENSIONS | | | 重量 (g) | 压力等级 MPa |
|------------------|--------------|--------------|---------------|------|----|--------|-------------|
| | T1 | T2 | L1 | L2 | S1 | | |
| 1J9-04 | 7/16"X20UNF | 7/16"X20UNF | 23 | 23 | 11 | 27 | 34.5 |
| 1J9-05 | 1/2"X20UNF | 1/2"X20UNF | 24.5 | 24.5 | 14 | 35 | |
| 1J9-06 | 9/16"X18UNF | 9/16"X18UNF | 26.9 | 26.9 | 14 | 46 | |
| 1J9-08 | 3/4"X16UNF | 3/4"X16UNF | 32 | 32 | 19 | 100 | 31 |
| 1J9-10 | 7/8"X14UNF | 7/8"X14UNF | 37.8 | 37.8 | 22 | 146 | 24 |
| 1J9-12 | 1.1/16"X12UN | 1.1/16"X12UN | 44.2 | 44.2 | 27 | 246 | |
| 1J9-14 | 1.3/16"X12UN | 1.3/16"X12UN | 47.5 | 47.5 | 30 | 361 | 31 |
| 1J9-16 | 1.5/16"X12UN | 1.5/16"X12UN | 46 | 46 | 33 | 363 | 21 |
| 1J9-20 | 1.5/8"X12UN | 1.5/8"X12UN | 55.5 | 55.5 | 41 | 363 | 17 |
| 1J9-24 | 1.7/8"X12UN | 1.7/8"X12UN | 62.5 | 62.5 | 48 | 863 | 14 |
| 1J9-32 | 2.1/2"X12UN | 2.1/2"X12UN | 78 | 78 | 63 | 1890 | 10.5 |

6J、6J-LN

美制JIC外螺纹74°外锥过板接头
JIC MALE 74° CONE BULKHEAD

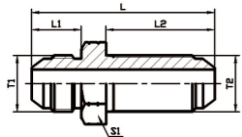

6J

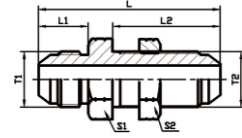

6J-LN



| 产品代号 PART NO. | 螺纹 THREAD | | 尺寸 DIMENSIONS | | | | | 重量 (g) | 压力等 级MPa |
|------------------|--------------|--------------|---------------|------|-------|----|----|-----------|-------------|
| | T1 | T2 | L1 | L2 | L | S1 | S2 | | |
| 6J-04 | 7/16"X20UNF | 7/16"X20UNF | 14 | 30.5 | 52.6 | 17 | 17 | 43 | 34.5 |
| 6J-05 | 1/2"X20UNF | 1/2"X20UNF | 14 | 30.5 | 52.6 | 19 | 19 | 53 | |
| 6J-06 | 9/16"X18UNF | 9/16"X18UNF | 14.1 | 32.5 | 55.4 | 22 | 22 | 69 | |
| 6J-08 | 3/4"X16UNF | 3/4"X16UNF | 16.7 | 36.5 | 62 | 24 | 24 | 119 | 31 |
| 6J-10 | 7/8"X14UNF | 7/8"X14UNF | 19.3 | 40.1 | 69.6 | 30 | 30 | 176 | 24 |
| 6J-12 | 1.1/16"X12UN | 1.1/16"X12UN | 21.9 | 44.4 | 78.5 | 36 | 36 | 287 | |
| 6J-14 | 1.3/16"X12UN | 1.3/16"X12UN | 22.6 | 44.4 | 79.2 | 38 | 38 | 327 | 21 |
| 6J-16 | 1.5/16"X12UN | 1.5/16"X12UN | 23.1 | 44.4 | 79.8 | 41 | 41 | 394 | |
| 6J-20 | 1.5/8"X12UN | 1.5/8"X12UN | 24.3 | 45.7 | 84.1 | 50 | 50 | 605 | 17 |
| 6J-24 | 1.7/8"X12UN | 1.7/8"X12UN | 27.5 | 46 | 89.4 | 55 | 55 | 766 | 14 |
| 6J-32 | 2.1/2"X12UN | 2.1/2"X12UN | 33.9 | 53.1 | 106.7 | 70 | 70 | 1514 | 10.5 |

注:如需带锁母定货,则请在代号后加“LN”,如6J-12LN。
Note: In case if you are interested to order the adapter with lock nut, please insert suffix "LN" after our part NO, for example 6J-12LN.

6J9、6J9-LN

美制JIC外螺纹74°外锥过板接头
JIC MALE 74° CONE BULKHEAD

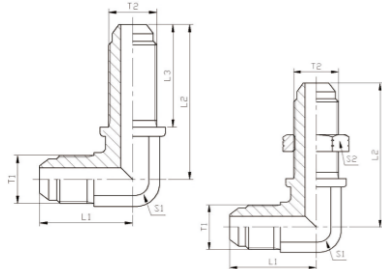

6J9

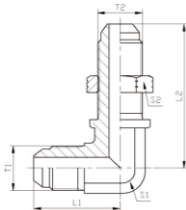

6J9-LN



| 产品代号 PART NO. | 螺纹 THREAD | | 尺寸 DIMENSIONS | | | | | 重量 (g) | 压力等 级MPa |
|------------------|--------------|--------------|---------------|------|------|----|----|-----------|-------------|
| | T1 | T2 | L1 | L2 | L3 | S1 | S2 | | |
| 6J9-04 | 7/16"X20UNF | 7/16"X20UNF | 24.6 | 40.4 | 26 | 11 | 17 | 38 | 34.5 |
| 6J9-05 | 1/2"X20UNF | 1/2"X20UNF | 26.9 | 43.7 | 26 | 14 | 19 | 51 | |
| 6J9-06 | 9/16"X18UNF | 9/16"X18UNF | 27.7 | 46 | 27.7 | 14 | 22 | 63 | |
| 6J9-08 | 3/4"X16UNF | 3/4"X16UNF | 34.5 | 53.6 | 31.7 | 19 | 27 | 122 | 31 |
| 6J9-10 | 7/8"X14UNF | 7/8"X14UNF | 39.6 | 60.7 | 35.3 | 22 | 27 | 195 | 24 |
| 6J9-12 | 1.1/16"X12UN | 1.1/16"X12UN | 45.2 | 67.8 | 39.5 | 27 | 36 | 315 | |
| 6J9-14 | 1.3/16"X12UN | 1.3/16"X12UN | 48.8 | 71.1 | 39.5 | 41 | 38 | 390 | 21 |
| 6J9-16 | 1.5/16"X12UN | 1.5/16"X12UN | 49.3 | 71.1 | 39.5 | 41 | 41 | 475 | |
| 6J9-20 | 1.5/8"X12UN | 1.5/8"X12UN | 55.1 | 79.5 | 41 | 41 | 48 | 767 | 17 |

注:如需带锁母定货,则请在代号后加“LN”,如6J9-12LN。
Note: In case if you are interested to order the adapter with lock nut, please insert suffix "LN" after our part NO, for example 6J9-12LN

AJ

美制JIC外螺纹74°外锥三通
90° JIC MALE 74° CONE TEE

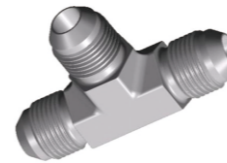
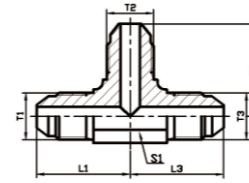

| 产品代号 PART NO. | 螺纹 THREAD | | | 尺寸 DIMENSIONS | | | | 重量 (g) | 压力等 级MPa |
|------------------|--------------|--------------|--------------|---------------|------|------|----|-----------|-------------|
| | T1 | T2 | T3 | L1 | L2 | L3 | S1 | | |
| AJ-04 | 7/16"X20UNF | 7/16"X20UNF | 7/16"X20UNF | 24.5 | 24.5 | 24.5 | 11 | 44 | 34.5 |
| AJ-05 | 1/2"X20UNF | 1/2"X20UNF | 1/2"X20UNF | 26 | 26 | 26 | 14 | 56 | |
| AJ-06 | 9/16"X18UNF | 9/16"X18UNF | 9/16"X18UNF | 26.9 | 26.9 | 26.9 | 14 | 70 | |
| AJ-08 | 3/4"X16UNF | 3/4"X16UNF | 3/4"X16UNF | 32 | 32 | 32 | 19 | 150 | 31 |
| AJ-10 | 7/8"X14UNF | 7/8"X14UNF | 7/8"X14UNF | 37.8 | 37.8 | 37.8 | 22 | 220 | 24 |
| AJ-12 | 1.1/16"X12UN | 1.1/16"X12UN | 1.1/16"X12UN | 44.2 | 44.2 | 44.2 | 27 | 370 | |
| AJ-16 | 1.3/16"X12UN | 1.3/16"X12UN | 1.3/16"X12UN | 49 | 49 | 49 | 33 | 558 | 21 |
| AJ-20 | 1.5/8"X12UN | 1.5/8"X12UN | 1.5/8"X12UN | 56.5 | 56.5 | 56.5 | 41 | 966 | 17 |
| AJ-24 | 1.7/8"X12UN | 1.7/8"X12UN | 1.7/8"X12UN | 63 | 63 | 63 | 48 | 1305 | 14 |
| AJ-32 | 2.1/2"X12UN | 2.1/2"X12UN | 2.1/2"X12UN | 78 | 78 | 78 | 63 | 2835 | 10.5 |

2J

美制JIC外螺纹74°外锥/JIC内螺纹74°内锥
JIC MALE 74° CONE/JIC FEMALE 74° SEAT

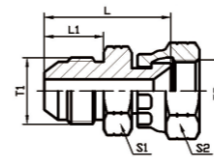

| 产品代号 PART NO. | 螺纹 THREAD | | 尺寸 DIMENSIONS | | | | 重量 (g) | 压力等 级MPa |
|------------------|--------------|--------------|---------------|------|----|----|-----------|-------------|
| | T1 | T2 | L1 | L | S1 | S2 | | |
| 2J-04 | 7/16"X20UNF | 7/16"X20UNF | 14 | 28 | 12 | 14 | 17 | 34.5 |
| 2J-04-05 | 7/16"X20UNF | 1/2"X20UNF | 14 | 28.5 | 12 | 17 | 19 | |
| 2J-04-06 | 7/16"X20UNF | 9/16"X18UNF | 14 | 28.5 | 14 | 19 | 23 | |
| 2J-04-08 | 7/16"X20UNF | 3/4"X16UNF | 14 | 30.5 | 19 | 24 | 31 | 31 |
| 2J-05 | 1/2"X20UNF | 1/2"X20UNF | 14 | 29 | 14 | 17 | 24 | 34.5 |
| 2J-05-06 | 1/2"X20UNF | 9/16"X18UNF | 14 | 28.5 | 14 | 19 | 25 | |
| 2J-05-08 | 1/2"X20UNF | 3/4"X16UNF | 14 | 30.5 | 19 | 24 | 33 | 31 |
| 2J-06 | 9/16"X18UNF | 9/16"X18UNF | 14.1 | 29 | 17 | 19 | 32 | 34.5 |
| 2J-06-08 | 9/16"X18UNF | 3/4"X16UNF | 14.1 | 31 | 19 | 24 | 36 | 31 |
| 2J-06-10 | 9/16"X18UNF | 7/8"X14UNF | 14.1 | 33.5 | 22 | 27 | 49 | 24 |
| 2J-08 | 3/4"X16UNF | 3/4"X16UNF | 16.7 | 36 | 22 | 24 | 61 | 31 |
| 2J-08-06 | 3/4"X16UNF | 9/16"X18UNF | 16.7 | 34 | 22 | 19 | 63 | |
| 2J-08-10 | 3/4"X16UNF | 7/8"X14UNF | 16.7 | 36.5 | 22 | 27 | 64 | 24 |
| 2J-08-12 | 3/4"X16UNF | 1.1/16"X12UN | 16.7 | 39.5 | 27 | 32 | 90 | |
| 2J-10 | 7/8"X14UNF | 7/8"X14UNF | 19.3 | 39 | 24 | 27 | 82 | |
| 2J-10-08 | 7/8"X14UNF | 3/4"X16UNF | 19.3 | 38 | 24 | 24 | 79 | 24 |
| 2J-10-12 | 7/8"X14UNF | 1.1/16"X12UN | 19.3 | 42 | 27 | 32 | 100 | |
| 2J-12 | 1.1/16"X12UN | 1.1/16"X12UN | 21.9 | 44.5 | 30 | 32 | 138 | 21 |
| 2J-12-10 | 1.1/16"X12UN | 7/8"X14UNF | 21.9 | 43.5 | 30 | 27 | 137 | |
| 2J-12-16 | 1.1/16"X12UN | 1.5/16"X12UN | 21.9 | 45.5 | 36 | 41 | 165 | |
| 2J-16 | 1.5/16"X12UN | 1.5/16"X12UN | 23.1 | 46.5 | 36 | 41 | 190 | 17 |
| 2J-16-20 | 1.5/16"X12UN | 1.5/8"X12UN | 23.1 | 53 | 41 | 50 | 260 | |
| 2J-20 | 1.5/8"X12UN | 1.5/8"X12UN | 24.3 | 54.5 | 46 | 50 | 359 | 14 |
| 2J-20-24 | 1.5/8"X12UN | 1.7/8"X12UN | 24.3 | 55.5 | 46 | 55 | 348 | |
| 2J-24 | 1.7/8"X12UN | 1.7/8"X12UN | 27.5 | 61 | 50 | 55 | 465 | 10.5 |
| 2J-24-32 | 1.7/8"X12UN | 2.1/2"X12UN | 27.5 | 63 | 65 | 75 | 626 | |
| 2J-32 | 2.1/2"X12UN | 2.1/2"X12UN | 33.9 | 69.5 | 65 | 75 | 853 | |

2J9

90°美制JIC外螺纹74°外锥/JIC内螺纹74°内锥
90° JIC MALE 74° CONE/JIC FEMALE 74° SEAT

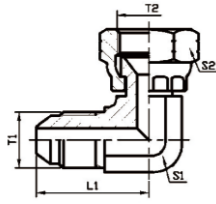

| 产品代号 PART NO. | 螺纹 THREAD | | 尺寸 DIMENSIONS | | | | 重量 (g) | 压力等级 MPa |
|------------------|---------------|---------------|---------------|----|----|------|--------|-------------|
| | T1 | T2 | L1 | S1 | S2 | | | |
| 2J9-04 | 7/16" X20UNF | 7/16" X20UNF | 22.6 | 11 | 14 | 18 | 34.5 | |
| 2J9-05 | 1/2" X20UNF | 1/2" X20UNF | 24.1 | 14 | 17 | 25 | | |
| 2J9-06 | 9/16" X18UNF | 9/16" X18UNF | 26.9 | 14 | 19 | 32 | | |
| 2J9-06-08 | 9/16" X18UNF | 3/4" X16UNF | 28.5 | 16 | 24 | 40 | 31 | |
| 2J9-08-06 | 3/4" X16UNF | 9/16" X18UNF | 32 | 19 | 19 | 65 | | |
| 2J9-08 | 3/4" X16UNF | 3/4" X16UNF | 32 | 19 | 24 | 70 | | |
| 2J9-08-10 | 3/4" X16UNF | 7/8" X14UNF | 32 | 19 | 27 | 79 | 24 | |
| 2J9-10 | 7/8" X14UNF | 7/8" X14UNF | 36.8 | 22 | 27 | 100 | | |
| 2J9-10-08 | 7/8" X14UNF | 3/4" X16UNF | 36.8 | 22 | 24 | 92 | | |
| 2J9-10-12 | 7/8" X14UNF | 1.1/16" X12UN | 39.5 | 24 | 32 | 123 | 21 | |
| 2J9-12 | 1.1/16" X12UN | 1.1/16" X12UN | 42.2 | 27 | 32 | 165 | | |
| 2J9-12-10 | 1.1/16" X12UN | 7/8" X14UNF | 42.2 | 27 | 27 | 147 | | |
| 2J9-12-16 | 1.1/16" X12UN | 1.5/16" X12UN | 46 | 30 | 41 | 195 | 17 | |
| 2J9-14 | 1.3/16" X12UN | 1.3/16" X12UN | 45.7 | 30 | 36 | 207 | | |
| 2J9-16 | 1.5/16" X12UN | 1.5/16" X12UN | 46 | 33 | 41 | 247 | | |
| 2J9-16-20 | 1.5/16" X12UN | 1.5/8" X12UN | 54 | 41 | 50 | 375 | 14 | |
| 2J9-20-16 | 1.5/8" X12UN | 1.5/16" X12UN | 52.3 | 41 | 41 | 365 | | |
| 2J9-20 | 1.5/8" X12UN | 1.5/8" X12UN | 52.3 | 41 | 50 | 460 | | |
| 2J9-20-24 | 1.5/8" X12UN | 1.7/8" X12UN | 59.5 | 48 | 55 | 524 | 10.5 | |
| 2J9-24-20 | 1.7/8" X12UN | 1.5/8" X12UN | 62.5 | 48 | 50 | 593 | | |
| 2J9-24 | 1.7/8" X12UN | 1.7/8" X12UN | 62.5 | 48 | 55 | 616 | | |
| 2J9-32 | 2.1/2" X12UN | 2.1/2" X12UN | 78 | 63 | 75 | 1271 | | |

BJ

美制JIC外螺纹74°外锥/美制JIC内螺纹74°内锥分支三通
JIC MALE 74° CONE/JIC FEMALE BRANCH TEE

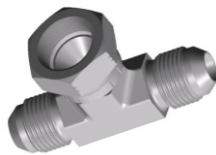
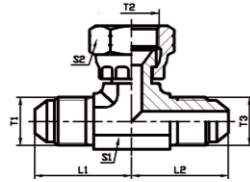

| 产品代号 PART NO. | 螺纹 THREAD | | | 尺寸 DIMENSIONS | | | | 重量 (g) | 压力等级 MPa |
|------------------|---------------|---------------|---------------|---------------|------|----|----|--------|-------------|
| | T1 | T2 | T3 | L1 | L2 | S1 | S2 | | |
| BJ-04 | 7/16" X20UNF | 7/16" X20UNF | 7/16" X20UNF | 23 | 23 | 11 | 14 | 32 | 34.5 |
| BJ-05 | 1/2" X20UNF | 1/2" X20UNF | 1/2" X20UNF | 24.5 | 24.5 | 14 | 17 | 44 | |
| BJ-06 | 9/16" X18UNF | 9/16" X18UNF | 9/16" X18UNF | 26.9 | 26.9 | 14 | 19 | 55 | |
| BJ-08 | 3/4" X16UNF | 3/4" X16UNF | 3/4" X16UNF | 32 | 32 | 19 | 24 | 109 | 31 |
| BJ-10 | 7/8" X14UNF | 7/8" X14UNF | 7/8" X14UNF | 37 | 37 | 22 | 27 | 172 | |
| BJ-12 | 1.1/16" X12UN | 1.1/16" X12UN | 1.1/16" X12UN | 42.5 | 42.5 | 27 | 32 | 284 | |
| BJ-14 | 1.3/16" X12UN | 1.3/16" X12UN | 1.3/16" X12UN | 45.7 | 45.7 | 30 | 36 | 347 | 24 |
| BJ-16 | 1.5/16" X12UN | 1.5/16" X12UN | 1.5/16" X12UN | 46 | 46 | 33 | 41 | 430 | |
| BJ-20 | 1.5/8" X12UN | 1.5/8" X12UN | 1.5/8" X12UN | 53 | 53 | 41 | 50 | 789 | |
| BJ-24 | 1.7/8" X12UN | 1.7/8" X12UN | 1.7/8" X12UN | 59.2 | 59.2 | 48 | 55 | 1002 | 17 |
| BJ-24 | 1.7/8" X12UN | 1.7/8" X12UN | 1.7/8" X12UN | 59.2 | 59.2 | 48 | 55 | 1002 | |
| BJ-32 | 2.1/2" X12UN | 2.1/2" X12UN | 2.1/2" X12UN | 77.7 | 77.7 | 63 | 75 | 2208 | |

CJ

美制JIC外螺纹74°外锥/美制JIC内螺纹74°内锥支三通
JIC MALE 74° CONE/JIC FEMALE RUN TEE

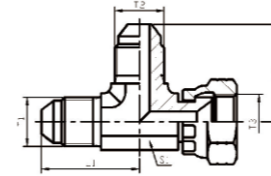

| 产品代号 PART NO. | 螺纹 THREAD | | | 尺寸 DIMENSIONS | | | | 重量 (g) | 压力等级 MPa |
|------------------|---------------|---------------|---------------|---------------|------|----|----|--------|-------------|
| | T1 | T2 | T3 | L1 | L2 | S1 | S2 | | |
| CJ-04 | 7/16" X20UNF | 7/16" X20UNF | 7/16" X20UNF | 23 | 23 | 11 | 14 | 32 | 34.5 |
| CJ-05 | 1/2" X20UNF | 1/2" X20UNF | 1/2" X20UNF | 24.5 | 24.5 | 14 | 17 | 44 | |
| CJ-06 | 9/16" X18UNF | 9/16" X18UNF | 9/16" X18UNF | 26.9 | 26.9 | 14 | 19 | 55 | |
| CJ-08 | 3/4" X16UNF | 3/4" X16UNF | 3/4" X16UNF | 32 | 32 | 19 | 24 | 109 | 31 |
| CJ-10 | 7/8" X14UNF | 7/8" X14UNF | 7/8" X14UNF | 37 | 37 | 22 | 27 | 172 | |
| CJ-12 | 1.1/16" X12UN | 1.1/16" X12UN | 1.1/16" X12UN | 42.5 | 42.5 | 27 | 32 | 284 | |
| CJ-14 | 1.3/16" X12UN | 1.3/16" X12UN | 1.3/16" X12UN | 45.7 | 45.7 | 30 | 36 | 347 | 24 |
| CJ-16 | 1.5/16" X12UN | 1.5/16" X12UN | 1.5/16" X12UN | 46 | 46 | 33 | 41 | 430 | |
| CJ-20 | 1.5/8" X12UN | 1.5/8" X12UN | 1.5/8" X12UN | 53 | 53 | 41 | 50 | 789 | |
| CJ-24 | 1.7/8" X12UN | 1.7/8" X12UN | 1.7/8" X12UN | 59.2 | 59.2 | 48 | 55 | 1002 | 17 |
| CJ-24 | 1.7/8" X12UN | 1.7/8" X12UN | 1.7/8" X12UN | 59.2 | 59.2 | 48 | 55 | 1002 | |
| CJ-32 | 2.1/2" X12UN | 2.1/2" X12UN | 2.1/2" X12UN | 77.7 | 77.7 | 63 | 75 | 2208 | |

3J

美制JIC内螺纹74°内锥
JIC FEMALE 74° SEAT

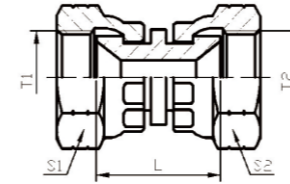

| 产品代号 PART NO. | 螺纹 THREAD | | 尺寸 DIMENSIONS | | | 重量 (g) | 压力等级 MPa |
|------------------|---------------|---------------|---------------|----|----|--------|-------------|
| | T1 | T2 | L | S1 | S2 | | |
| 3J-04 | 7/16" X20UNF | 7/16" X20UNF | 19 | 15 | 15 | 25 | 34.5 |
| 3J-05 | 1/2" X20UNF | 1/2" X20UNF | 21 | 17 | 17 | 35 | |
| 3J-06 | 9/16" X18UNF | 9/16" X18UNF | 21 | 19 | 19 | 44 | |
| 3J-06-08 | 9/16" X18UNF | 3/4" X16UNF | 23 | 19 | 24 | 67 | 31 |
| 3J-08 | 3/4" X16UNF | 3/4" X16UNF | 26 | 24 | 24 | 98 | |
| 3J-10 | 7/8" X14UNF | 7/8" X14UNF | 27 | 27 | 27 | 133 | |
| 3J-12 | 1.1/16" X12UN | 1.1/16" X12UN | 29 | 32 | 32 | 209 | 24 |
| 3J-16 | 1.5/16" X12UN | 1.5/16" X12UN | 29 | 41 | 41 | 309 | |
| 3J-20 | 1.5/8" X12UN | 1.5/8" X12UN | 35 | 50 | 50 | 556 | |
| 3J-24 | 1.7/8" X12UN | 1.7/8" X12UN | 35.5 | 55 | 55 | 730 | 17 |
| 3J-24 | 1.7/8" X12UN | 1.7/8" X12UN | 35.5 | 55 | 55 | 730 | |
| 3J-24 | 1.7/8" X12UN | 1.7/8" X12UN | 35.5 | 55 | 55 | 730 | |

4J

美制JIC外螺纹74°外锥堵头
JIC MALE 74° CONE PLUG

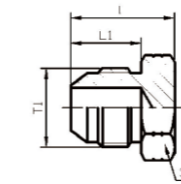

| 产品代号 PART NO. | 螺纹 THREAD | 尺寸 DIMENSIONS | | | 重量 (g) | 压力等级 MPa |
|------------------|---------------|---------------|------|----|--------|-------------|
| | T1 | L1 | L | S1 | | |
| 4J-04 | 7/16" X20UNF | 14 | 20.3 | 12 | 15 | 34.5 |
| 4J-05 | 1/2" X20UNF | 14 | 20.3 | 14 | 19 | |
| 4J-06 | 9/16" X18UNF | 14.1 | 20.3 | 17 | 24 | |
| 4J-08 | 3/4" X16UNF | 16.7 | 23.9 | 22 | 50 | 31 |
| 4J-10 | 7/8" X14UNF | 19.3 | 27.9 | 24 | 71 | |
| 4J-12 | 1.1/16" X12UN | 21.9 | 32.5 | 30 | 126 | |
| 4J-14 | 1.3/16" X12UN | 22.6 | 33.3 | 32 | 148 | 24 |
| 4J-16 | 1.5/16" X12UN | 23.1 | 34 | 36 | 187 | |
| 4J-20 | 1.5/8" X12UN | 24.3 | 36.8 | 46 | 317 | |
| 4J-24 | 1.7/8" X12UN | 27.5 | 42 | 50 | 434 | 17 |
| 4J-24 | 1.7/8" X12UN | 27.5 | 42 | 50 | 434 | |
| 4J-32 | 2.1/2" X12UN | 33.9 | 52 | 65 | 926 | |

9J

美制JIC内螺纹74°内锥堵头
JIC FEMALE 74° SEAT PLUG

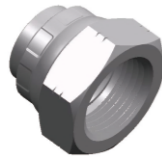
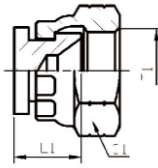

| 产品代号 PART NO. | 螺纹 THREAD | | 尺寸 DIMENSIONS | | | 重量 (g) | 压力等级 MPa |
|------------------|--------------|--|---------------|----|--|--------|-------------|
| | T1 | | L1 | S1 | | | |
| 9J-04 | 7/16"X20UNF | | 9 | 15 | | 4 | 34.5 |
| 9J-05 | 1/2"X20UNF | | 9.5 | 17 | | 6 | |
| 9J-06 | 9/16"X18UNF | | 10.5 | 19 | | 7 | |
| 9J-08 | 3/4"X16UNF | | 11 | 24 | | 15 | 31 |
| 9J-10 | 7/8"X14UNF | | 13 | 27 | | 25 | |
| 9J-12 | 1.1/16"X12UN | | 15 | 32 | | 40 | 24 |
| 9J-14 | 1.3/16"X12UN | | 15 | 36 | | 50 | |
| 9J-16 | 1.5/16"X12UN | | 16 | 41 | | 65 | 21 |
| 9J-20 | 1.5/8"X12UN | | 17 | 50 | | 108 | |
| 9J-24 | 1.7/8"X12UN | | 20 | 55 | | 157 | 14 |
| 9J-32 | 2.1/2"X12UN | | 23.5 | 75 | | 297 | 10.5 |

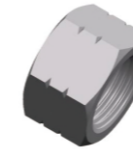
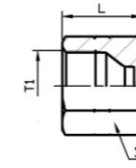

9J-CAP

美制JIC内螺纹74°内锥堵头
JIC FEMALE 74° SEAT PLUG

| 代号 PART NO. | 螺纹 THREAD | | 尺寸 DIMENSIONS | | | 重量 (g) | 压力等级 MPa |
|----------------|--------------|--|---------------|----|--|--------|-------------|
| | T1 | | L | S1 | | | |
| 9J-04CAP | 7/16"X20UNF | | 15.1 | 14 | | 15 | 34.5 |
| 9J-05CAP | 1/2"X20UNF | | 15.5 | 17 | | 20 | |
| 9J-06CAP | 9/16"X18UNF | | 15.9 | 19 | | 24 | |
| 9J-08CAP | 3/4"X16UNF | | 19 | 24 | | 45 | 31 |
| 9J-10CAP | 7/8"X14UNF | | 21.4 | 27 | | 64 | |
| 9J-12CAP | 1.1/16"X12UN | | 23 | 32 | | 88 | 24 |
| 9J-16CAP | 1.5/16"X12UN | | 25.8 | 41 | | 172 | |
| 9J-20CAP | 1.5/8"X12UN | | 27 | 50 | | 259 | 17 |
| 9J-24CAP | 1.7/8"X12UN | | 30.2 | 60 | | 431 | 14 |
| 9J-32CAP | 2.1/2"X12UN | | 36.5 | 75 | | 724 | 10.5 |

1JG

美制JIC外螺纹74°外锥/英管外螺纹O形圈
JIC MALE 74° CONE/BSP MALE O-RING

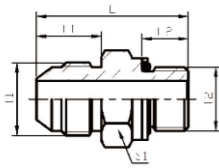

| 产品代号 PART NO. | 螺纹 THREAD | | 尺寸 DIMENSIONS | | | | 重量 (g) | 压力等级 MPa |
|------------------|--------------|------------|---------------|----|------|----|--------|-------------|
| | T1 | T2 | L1 | L2 | L | S1 | | |
| 1JG-04-02 | 7/16"X20UNF | G1/8"X28 | 14 | 8 | 28.7 | 17 | 23 | 34.5 |
| 1JG-04 | 7/16"X20UNF | G1/4"X19 | 14 | 12 | 32 | 19 | 40 | |
| 1JG-04-06 | 7/16"X20UNF | G3/8"X19 | 14 | 12 | 33 | 22 | 49 | |
| 1JG-04-08 | 7/16"X20UNF | G1/2"X14 | 14 | 14 | 38.6 | 27 | 102 | 31.5 |
| 1JG-05-04 | 1/2"X20UNF | G1/4"X19 | 14 | 12 | 32 | 19 | 38 | |
| 1JG-05-06 | 1/2"X20UNF | G3/8"X19 | 14 | 12 | 33 | 22 | 50 | 31.5 |
| 1JG-06-04 | 9/16"X18UNF | G1/4"X19 | 14.1 | 12 | 32 | 19 | 37 | 34.5 |
| 1JG-06 | 9/16"X18UNF | G3/8"X19 | 14.1 | 12 | 33 | 22 | 52 | |
| 1JG-06-08 | 9/16"X18UNF | G1/2"X14 | 14.1 | 14 | 38.6 | 27 | 105 | 31.5 |
| 1JG-08-04 | 3/4"X16UNF | G1/4"X19 | 16.7 | 12 | 35 | 19 | 55 | |
| 1JG-08-06 | 3/4"X16UNF | G3/8"X19 | 16.7 | 12 | 36 | 22 | 68 | 31 |
| 1JG-08 | 3/4"X16UNF | G1/2"X14 | 16.7 | 14 | 41.4 | 27 | 120 | |
| 1JG-08-12 | 3/4"X16UNF | G3/4"X14 | 16.7 | 16 | 42.4 | 32 | 154 | 20 |
| 1JG-10-06 | 7/8"X14UNF | G3/8"X19 | 19.3 | 12 | 39.1 | 24 | 88 | |
| 1JG-10-08 | 7/8"X14UNF | G1/2"X14 | 19.3 | 14 | 43.9 | 27 | 131 | 24 |
| 1JG-12-08 | 1.1/16"X12UN | G1/2"X14 | 22 | 14 | 46.7 | 27 | 149 | |
| 1JG-12 | 1.1/16"X12UN | G3/4"X14 | 21.9 | 16 | 47.5 | 32 | 188 | 20 |
| 1JG-12-16 | 1.1/16"X12UN | G1"X11 | 21.9 | 18 | 42.6 | 46 | 178 | |
| 1JG-16-12 | 1.5/16"X12UN | G3/4"X14 | 23 | 16 | 47.5 | 36 | 212 | 20 |
| 1JG-16 | 1.5/16"X12UN | G1"X11 | 23.1 | 18 | 53.6 | 46 | 329 | |
| 1JG-16-20 | 1.5/16"X12UN | G1.1/4"X11 | 23.1 | 20 | 55.1 | 50 | 396 | 17 |
| 1JG-20 | 1.5/8"X12UN | G1.1/4"X11 | 24.3 | 20 | 56.9 | 50 | 449 | |
| 1JG-24-20 | 1.7/8"X12UN | G1.1/4"X11 | 27.5 | 20 | 60.4 | 50 | 504 | 14 |
| 1JG-24 | 1.7/8"X12UN | G1.1/2"X11 | 27.5 | 22 | 61 | 55 | 549 | |

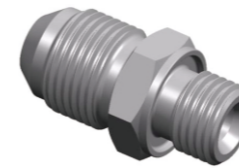
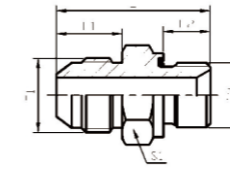

1JB-WD

美制JIC外螺纹74°外锥/英管外螺纹胶垫密封
JIC MALE 74° CONE/BSP MALE CAPTIVE SEAL

| 产品代号 PART NO. | 螺纹 THREAD | | 尺寸 DIMENSIONS | | | | 重量 (g) | 压力等级 MPa |
|------------------|--------------|------------|---------------|----|------|----|--------|-------------|
| | T1 | T2 | L1 | L2 | L | S1 | | |
| 1JB-04-02WD | 7/16"X20UNF | G1/8"X28 | 14 | 8 | 30 | 14 | 26 | 34.5 |
| 1JB-04-04WD | 7/16"X20UNF | G1/4"X19 | 14 | 12 | 34.8 | 19 | 38 | |
| 1JB-04-06WD | 7/16"X20UNF | G3/8"X19 | 14 | 12 | 35.7 | 22 | 52 | |
| 1JB-04-08WD | 7/16"X20UNF | G1/2"X14 | 14 | 14 | 39.2 | 27 | 105 | |
| 1JB-05-02WD | 1/2"X20UNF | G1/8"X28 | 14 | 8 | 30 | 14 | 25 | |
| 1JB-05-04WD | 1/2"X20UNF | G1/4"X19 | 14 | 12 | 34.8 | 19 | 25 | |
| 1JB-05-06WD | 1/2"X20UNF | G3/8"X19 | 14 | 12 | 35.7 | 22 | 57 | |
| 1JB-06-02WD | 9/16"X18UNF | G1/8"X28 | 14 | 8 | 31 | 17 | 32 | |
| 1JB-06-04WD | 9/16"X18UNF | G1/4"X19 | 14.1 | 12 | 35.1 | 19 | 44 | |
| 1JB-06WD | 9/16"X18UNF | G3/8"X19 | 14.1 | 12 | 36 | 22 | 58 | |
| 1JB-06-08WD | 9/16"X18UNF | G1/2"X14 | 14.1 | 14 | 39.4 | 27 | 101 | 31 |
| 1JB-08-04WD | 3/4"X16UNF | G1/4"X19 | 16.7 | 12 | 39 | 19 | 61 | |
| 1JB-08-06WD | 3/4"X16UNF | G3/8"X19 | 16.7 | 12 | 39 | 22 | 59 | |
| 1JB-08WD | 3/4"X16UNF | G1/2"X14 | 16.7 | 14 | 42 | 27 | 115 | |
| 1JB-08-12WD | 3/4"X16UNF | G3/4"X14 | 16.7 | 16 | 45.6 | 32 | 177 | 27.5 |
| 1JB-10-06WD | 7/8"X14UNF | G3/8"X19 | 19.3 | 12 | 42.6 | 24 | 98 | |
| 1JB-10-08WD | 7/8"X14UNF | G1/2"X14 | 19.3 | 14 | 44.5 | 27 | 126 | 24 |
| 1JB-10-12WD | 7/8"X14UNF | G3/4"X14 | 19.3 | 16 | 48.1 | 32 | 162 | |
| 1JB-12WD | 1.1/16"X12UN | G3/4"X14 | 21.9 | 16 | 50.9 | 32 | 211 | |
| 1JB-12-06WD | 1.1/16"X12UN | G3/8"X19 | 21.9 | 12 | 50.1 | 27 | 157 | |
| 1JB-12-08WD | 1.1/16"X12UN | G1/2"X14 | 21.9 | 14 | 49 | 32 | 160 | 20.5 |
| 1JB-12-16WD | 1.1/16"X12UN | G1"X11 | 21.9 | 18 | 53.4 | 41 | 312 | |
| 1JB-16-12WD | 1.5/16"X12UN | G3/4"X14 | 23.1 | 16 | 52.7 | 36 | 245 | 21 |
| 1JB-16WD | 1.5/16"X12UN | G1"X11 | 23.1 | 18 | 54.7 | 41 | 342 | |
| 1JB-16-20WD | 1.5/16"X12UN | G1.1/4"X11 | 23.1 | 20 | 58.7 | 50 | 382 | 17 |
| 1JB-20-16WD | 1.5/8"X12UN | G1"X11 | 24.3 | 18 | 62.1 | 46 | 456 | |
| 1JB-20WD | 1.5/8"X12UN | G1.1/4"X11 | 24.3 | 20 | 60 | 50 | 488 | 10.5 |
| 1JB-20-24WD | 1.5/8"X12UN | G1.1/2"X11 | 24.3 | 22 | 63.8 | 55 | 590 | |
| 1JB-24-20WD | 1.7/8"X12UN | G1.1/4"X11 | 27.5 | 20 | 62 | 50 | 544 | 14 |
| 1JB-24WD | 1.7/8"X12UN | G1.1/2"X11 | 27.5 | 22 | 67.1 | 55 | 633 | |

2BJ-WD

英管外螺纹胶垫密封/JIC内螺纹74°内锥
BSP MALE CAPTIVE SEAL/JICFEMALE 74°SEAT

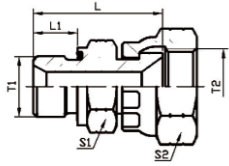

| 产品代号 PART NO. | 螺纹 THREAD | | 尺寸 DIMENSIONS | | | | 重量 (g) | 压力等级 MPa |
|------------------|------------|--------------|---------------|------|----|----|-----------|-------------|
| | T1 | T2 | L1 | L | S1 | S2 | | |
| 2BJ-02-04WD | G1/8"X28 | 7/16"X20UNF | 8 | 24 | 14 | 15 | 57 | 34.5 |
| 2BJ-02-05WD | G1/8"X28 | 1/2"X20UNF | 8 | 24.7 | 14 | 17 | 55 | |
| 2BJ-04-05WD | G1/4"X19 | 1/2"X20UNF | 12 | 29.4 | 19 | 17 | 116 | |
| 2BJ-04-06WD | G1/4"X19 | 9/16"X18UNF | 12 | 30.4 | 19 | 19 | 110 | |
| 2BJ-04-08WD | G1/4"X19 | 3/4"X16UNF | 12 | 33.4 | 19 | 22 | 165 | 31 |
| 2BJ-06WD | G3/8"X19 | 9/16"X18UNF | 12 | 31.3 | 22 | 19 | 165 | |
| 2BJ-06-08WD | G3/8"X19 | 3/4"X16UNF | 12 | 45.2 | 22 | 22 | 225 | |
| 2BJ-06-10WD | G3/8"X19 | 7/8"X14UNF | 12 | 35.4 | 22 | 27 | 238 | |
| 2BJ-08-10WD | G1/2"X14 | 7/8"X14UNF | 14 | 51.4 | 27 | 27 | 275 | 24 |
| 2BJ-08-12WD | G1/2"X14 | 1.1/16"X12UN | 14 | 39.7 | 27 | 32 | 323 | |
| 2BJ-12WD | G3/4"X14 | 1.1/16"X12UN | 16 | 41.5 | 32 | 32 | 495 | |
| 2BJ-12-16WD | G3/4"X14 | 1.5/16"X12UN | 16 | 43.2 | 32 | 41 | 528 | |
| 2BJ-16WD | G1"X11 | 1.5/16"X12UN | 18 | 45.2 | 41 | 41 | 744 | 21 |
| 2BJ-16-20WD | G1"X11 | 1.5/8"X12UN | 18 | 54 | 41 | 50 | 700 | |
| 2BJ-20WD | G1.1/4"X11 | 1.5/8"X12UN | 20 | 52 | 50 | 50 | 1150 | 16 |
| 2BJ-20-24WD | G1.1/4"X11 | 1.7/8"X12UN | 20 | 55.9 | 55 | 60 | 1102 | |
| 2BJ-24WD | G1.1/2"X11 | 1.7/8"X12UN | 22 | 62 | 50 | 60 | 1132 | |

1JG4-OG

45°美制JIC外螺纹74°外锥/英管外螺纹O形圈可调柱端
45°JIC MALE 74°CONE/BSP MALE O-RING Adjustable Stud End

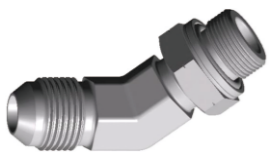
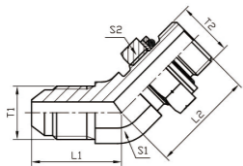

| 产品代号 PART NO. | 螺纹 THREAD | | 尺寸 DIMENSIONS | | | | 重量 (g) | 压力等级 MPa |
|------------------|--------------|------------|---------------|------|----|----|-----------|-------------|
| | T1 | T2 | L1 | L2 | S1 | S2 | | |
| 1JG4-04OG | 7/16"X20UNF | G1/4"X19 | 21 | 28 | 14 | 19 | 35 | 31.5 |
| 1JG4-05-04OG | 1/2"X20UNF | G1/4"X19 | 21 | 28 | 14 | 19 | 37 | |
| 1JG4-06-04OG | 9/16"X18UNF | G1/4"X19 | 22 | 28 | 14 | 19 | 38 | |
| 1JG4-06OG | 9/16"X18UNF | G3/8"X19 | 23 | 32 | 19 | 22 | 60 | |
| 1JG4-08-06OG | 3/4"X16UNF | G3/8"X19 | 25.8 | 32 | 19 | 22 | 80 | 25 |
| 1JG4-08OG | 3/4"X16UNF | G1/2"X14 | 27.8 | 36 | 22 | 27 | 115 | |
| 1JG4-10-08OG | 7/8"X14UNF | G1/2"X14 | 29.5 | 38 | 22 | 27 | 133 | 24 |
| 1JG4-10OG | 7/8"X14UNF | G5/8"X14 | 29.5 | 38 | 22 | 30 | 138 | |
| 1JG4-12-10OG | 1.1/16"X12UN | G5/8"X14 | 34 | 38.5 | 27 | 30 | 176 | |
| 1JG4-12-16OG | 1.1/16"X12UN | G1"X11 | 37.5 | 44 | 33 | 41 | 277 | |
| 1JG4-12OG | 1.1/16"X12UN | G3/4"X14 | 32.5 | 42 | 27 | 32 | 201 | 16 |
| 1JG4-16-12OG | 1.5/16"X12UN | G3/4"X14 | 38 | 44 | 33 | 32 | 266 | |
| 1JG4-16OG | 1.5/16"X12UN | G1"X11 | 38 | 44 | 33 | 41 | 322 | |
| 1JG4-20OG | 1.5/8"X12UN | G1.1/4"X11 | 43 | 47.5 | 41 | 50 | 530 | |
| 1JG4-24OG | 1.7/8"X12UN | G1.1/2"X11 | 49 | 51.5 | 48 | 55 | 698 | 14 |

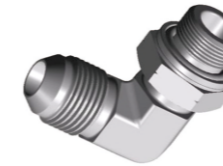
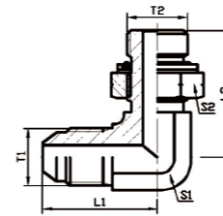

1JG9-OG

90°弯美制JIC外螺纹74°外锥/英管外螺纹O形圈密封可调柱端
90° ELBOW JIC MALE 74°CONE/BSP MALE O-RING Adjustable Stud End

| 产品代号 PART NO. | 螺纹 THREAD | | 尺寸 DIMENSIONS | | | | 重量 (g) | 压力等级 MPa |
|------------------|--------------|------------|---------------|------|----|----|-----------|-------------|
| | T1 | T2 | L1 | L2 | S1 | S2 | | |
| 1JG9-04-02OG | 7/16"X20UNF | G1/8"X28 | 22.6 | 26.2 | 11 | 14 | 25 | 31.5 |
| 1JG9-04OG | 7/16"X20UNF | G1/4"X19 | 22.6 | 31.8 | 14 | 19 | 41 | |
| 1JG9-05-02OG | 1/2"X20UNF | G1/8"X28 | 24.1 | 27.7 | 14 | 14 | 30 | |
| 1JG9-05-04OG | 1/2"X20UNF | G1/4"X19 | 26.6 | 31.8 | 14 | 19 | 45 | |
| 1JG9-05-06OG | 1/2"X20UNF | G3/8"X19 | 28.5 | 35.8 | 16 | 22 | 67 | 25 |
| 1JG9-06-04OG | 9/16"X18UNF | G1/4"X19 | 26.9 | 31.8 | 14 | 19 | 45 | 31.5 |
| 1JG9-06-06OG | 9/16"X18UNF | G3/8"X19 | 29 | 35.8 | 19 | 22 | 71 | 25 |
| 1JG9-08-04OG | 3/4"X16UNF | G1/4"X19 | 31.8 | 36.8 | 19 | 19 | 79 | 31.5 |
| 1JG9-08-06OG | 3/4"X16UNF | G3/8"X19 | 31.8 | 36.8 | 19 | 22 | 90 | 25 |
| 1JG9-08OG | 3/4"X16UNF | G1/2"X14 | 33.8 | 43.2 | 22 | 27 | 139 | |
| 1JG9-10-06OG | 7/8"X14UNF | G3/8"X19 | 36.8 | 37.1 | 22 | 22 | 112 | |
| 1JG9-10-08OG | 7/8"X14UNF | G1/2"X14 | 36.8 | 43.2 | 22 | 27 | 142 | |
| 1JG9-10-12OG | 7/8"X14UNF | G3/4"X14 | 39.2 | 49.3 | 27 | 32 | 205 | 16 |
| 1JG9-12-08OG | 1.1/16"X12UN | G1/2"X14 | 42.2 | 49.3 | 27 | 27 | 176 | 25 |
| 1JG9-12OG | 1.1/16"X12UN | G3/4"X14 | 42.2 | 49.3 | 27 | 32 | 247 | 16 |
| 1JG9-12-16OG | 1.1/16"X12UN | G1"X11 | 44.7 | 52.1 | 33 | 41 | 329 | 16 |
| 1JG9-16-12OG | 1.5/16"X12UN | G3/4"X14 | 46 | 48.2 | 33 | 32 | 308 | |
| 1JG9-16OG | 1.5/16"X12UN | G1"X11 | 46 | 52.1 | 33 | 41 | 385 | |
| 1JG9-20-16OG | 1.5/8"X12UN | G1"X11 | 52.3 | 57.2 | 41 | 41 | 522 | |
| 1JG9-20OG | 1.5/8"X12UN | G1.1/4"X11 | 52.3 | 57.2 | 41 | 50 | 641 | 14 |
| 1JG9-24-20OG | 1.7/8"X12UN | G1.1/4"X11 | 59.2 | 60.7 | 48 | 50 | 865 | |
| 1JG01-24OG | 1.7/8"X12UN | G1.1/2"X11 | 59.2 | 60.7 | 48 | 55 | 833 | |

1JM-WD

JIC外螺纹74°外锥/公制螺纹胶垫密封
JIC MALE 74°CONE/METRIC THREAD MALE CAPTIVE SEAL

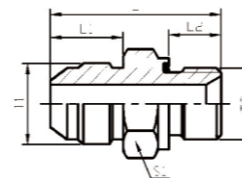

| 产品代号 PART NO. | 螺纹 THREAD | | 尺寸 DIMENSIONS | | | | 重量 (g) | 压力等级 MPa |
|------------------|--------------|---------|---------------|----|------|----|-----------|-------------|
| | T1 | T2 | L1 | L2 | L | S1 | | |
| 1JM-04-10WD | 7/16"X20UNF | M10X1 | 14 | 8 | 31 | 14 | 25 | 34.5 |
| 1JM-05-12WD | 1/2"X20UNF | M12X1.5 | 14 | 12 | 33.5 | 17 | 33 | |
| 1JM-06-14WD | 9/16"X18UNF | M14X1.5 | 14.1 | 12 | 33.5 | 19 | 40 | |
| 1JM-06-16WD | 9/16"X18UNF | M16X1.5 | 14.1 | 12 | 35.1 | 22 | 55 | |
| 1JM-08-16WD | 3/4"X16UNF | M16X1.5 | 16.7 | 12 | 37.6 | 22 | 66 | 31 |
| 1JM-08-18WD | 3/4"X16UNF | M18X1.5 | 16.7 | 14 | 39.1 | 24 | 79 | |
| 1JM-10-18WD | 7/8"X14UNF | M18X1.5 | 19.3 | 12 | 41.7 | 24 | 95 | 24 |
| 1JM-10-22WD | 7/8"X14UNF | M22X1.5 | 19.3 | 14 | 42.9 | 27 | 110 | |
| 1JM-12-22WD | 1.1/16"X12UN | M22X1.5 | 21.9 | 16 | 45.5 | 27 | 120 | |
| 1JM-12-27WD | 1.1/16"X12UN | M27X2 | 21.9 | 16 | 49 | 32 | 180 | |
| 1JM-16-33WD | 1.5/16"X12UN | M33X2 | 23.1 | 18 | 51.6 | 41 | 272 | 21 |
| 1JM-20-42WD | 1.5/8"X12UN | M42X2 | 24.3 | 20 | 54.9 | 50 | 424 | 17 |

1JH4-OG

45°美制JIC外螺纹74°外锥/公制外螺纹可调向柱端轻系列ISO 6149-3
45°JIC MALE 74° CONE/METRIC MALE ADJUSTABLE STUD END L-SERIES ISO 6149-3

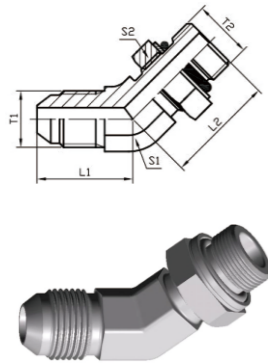

| 产品代号 PART NO. | 螺纹 THREAD | | 尺寸 DIMENSIONS | | | | 重量 (g) | 压力等级 MPa |
|------------------|---------------|---------|---------------|------|----|----|-----------|-------------|
| | T1 | T2 | L1 | L2 | S1 | S2 | | |
| 1JH4-04-10OG | 7/16" X20UNF | M10X1 | 21.5 | 23.5 | 11 | 14 | 24 | 31.5 |
| 1JH4-04-12OG | 7/16" X20UNF | M12X1.5 | 21.5 | 27.5 | 11 | 17 | 32 | |
| 1JH4-04-14OG | 7/16" X20UNF | M14X1.5 | 22.3 | 28.3 | 14 | 19 | 37 | |
| 1JH4-05-12OG | 1/2" X20UNF | M12X1.5 | 22.3 | 28.3 | 14 | 17 | 34 | |
| 1JH4-05-14OG | 1/2" X20UNF | M14X1.5 | 22.3 | 28.3 | 14 | 19 | 40 | |
| 1JH4-06-14OG | 9/16" X18UNF | M14X1.5 | 22.3 | 28.3 | 14 | 19 | 43 | |
| 1JH4-06-16OG | 9/16" X18UNF | M16X1.5 | 22.3 | 29 | 16 | 22 | 53 | 25 |
| 1JH4-08-16OG | 3/4" X16UNF | M16X1.5 | 26.8 | 30 | 19 | 22 | 71 | |
| 1JH4-08-18OG | 3/4" X16UNF | M18X1.5 | 26.8 | 31 | 19 | 24 | 84 | 24 |
| 1JH4-10-16OG | 7/8" X14UNF | M16X1.5 | 31 | 31 | 22 | 22 | 86 | |
| 1JH4-10-18OG | 7/8" X14UNF | M18X1.5 | 31 | 32 | 22 | 24 | 104 | |
| 1JH4-10-22OG | 7/8" X14UNF | M22X1.5 | 31 | 33 | 22 | 27 | 123 | |
| 1JH4-12-22OG | 1.1/16" X12UN | M22X1.5 | 35.5 | 34.5 | 27 | 27 | 165 | 16 |
| 1JH4-12-27OG | 1.1/16" X12UN | M27X2 | 32.5 | 39.5 | 27 | 32 | 202 | |
| 1JH4-16-27OG | 1.5/16" X12UN | M27X2 | 38.5 | 41 | 33 | 32 | 267 | |
| 1JH4-16-33OG | 1.5/16" X12UN | M33X2 | 38.5 | 41.5 | 33 | 41 | 310 | |
| 1JH4-20-42OG | 1.5/8" X12UN | M42X2 | 43 | 45 | 41 | 50 | 517 | |
| 1JH4-24-48OG | 1.7/8" X12UN | M48X2 | 49 | 49.5 | 48 | 55 | 690 | |

1JH9-OG

90°弯美制JIC外螺纹74°外锥/公制外螺纹可调向柱端轻系列ISO 6149-3
90° ELBOW JIC MALE 74° CONE/METRIC MALE ADJUSTABLE STUD END L-SERIES ISO 6149-3

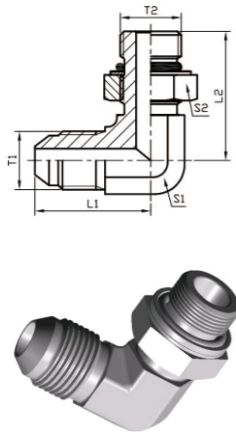

| 产品代号 PART NO. | 螺纹 THREAD | | 尺寸 DIMENSIONS | | | | 重量 (g) | 压力等级 MPa |
|------------------|---------------|---------|---------------|------|----|----|-----------|-------------|
| | T1 | T2 | L1 | L2 | S1 | S2 | | |
| 1JH9-04-10OG | 7/16" X20UNF | M10X1 | 22.6 | 25 | 11 | 14 | 25 | 31.5 |
| 1JH9-05-12OG | 1/2" X20UNF | M12X1.5 | 24.1 | 30 | 14 | 17 | 37 | |
| 1JH9-06-14OG | 9/16" X18UNF | M14X1.5 | 26.9 | 34.9 | 14 | 19 | 52 | |
| 1JH9-08-16OG | 3/4" X16UNF | M16X1.5 | 31.8 | 35.9 | 19 | 22 | 85 | 25 |
| 1JH9-08-18OG | 3/4" X16UNF | M18X1.5 | 31.8 | 36.8 | 19 | 24 | 100 | |
| 1JH9-10-18OG | 7/8" X14UNF | M18X1.5 | 36.8 | 40.7 | 22 | 24 | 112 | 24 |
| 1JH9-10-22OG | 7/8" X14UNF | M22X1.5 | 36.8 | 41.7 | 22 | 27 | 150 | |
| 1JH9-12-22OG | 1.1/16" X12UN | M22X1.5 | 42.2 | 44.4 | 27 | 27 | 201 | |
| 1JH9-12-27OG | 1.1/16" X12UN | M27X2 | 42.2 | 48.5 | 27 | 32 | 253 | 16 |
| 1JH9-16-33OG | 1.5/16" X12UN | M33X2 | 46 | 51.2 | 33 | 41 | 377 | |

1JO

美制JIC外螺纹74°外锥/SAE外螺纹带O形圈轻系列ISO 11926-3
JIC MALE 74° CONE/SAE O-RING BOSS L-SERIES ISO 11926-3

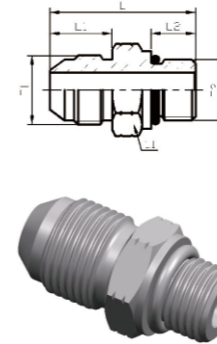

| 产品代号 PART NO. | 螺纹 THREAD | | 尺寸 DIMENSIONS | | | | 重量 (g) | 压力等级 MPa |
|------------------|---------------|---------------|---------------|-------|------|----|-----------|-------------|
| | T1 | T2 | L1 | L2 | L | S1 | | |
| 1JO-04 | 7/16" X20UNF | 7/16" X20UNF | 14 | 9.14 | 31.2 | 14 | 25 | 31.5 |
| 1JO-04-05 | 7/16" X20UNF | 1/2" X20UNF | 14 | 9.14 | 31.2 | 17 | 31 | |
| 1JO-04-06 | 7/16" X20UNF | 9/16" X18UNF | 14 | 10 | 32.7 | 17 | 33 | |
| 1JO-05 | 1/2" X20UNF | 1/2" X20UNF | 14 | 9.14 | 31.2 | 17 | 33 | |
| 1JO-05-04 | 1/2" X20UNF | 7/16" X20UNF | 14 | 9.14 | 31 | 14 | 26 | |
| 1JO-05-06 | 1/2" X20UNF | 9/16" X18UNF | 14 | 9.93 | 33 | 17 | 20 | |
| 1JO-06 | 9/16" X18UNF | 9/16" X18UNF | 14.1 | 9.93 | 33 | 17 | 22 | |
| 1JO-06-04 | 9/16" X18UNF | 7/16" X20UNF | 14.1 | 9.14 | 32.2 | 17 | 35 | |
| 1JO-06-05 | 9/16" X18UNF | 1/2" X20UNF | 14.1 | 9 | 32.2 | 17 | 36 | |
| 1JO-06-08 | 9/16" X18UNF | 3/4" X16UNF | 14.1 | 11 | 35.1 | 22 | 61 | |
| 1JO-08 | 3/4" X16UNF | 3/4" X16UNF | 16.7 | 11.13 | 37.6 | 22 | 75 | |
| 1JO-08-04 | 3/4" X16UNF | 7/16" X20UNF | 16.7 | 9 | 34 | 22 | 61 | |
| 1JO-08-06 | 3/4" X16UNF | 9/16" X18UNF | 16.7 | 10 | 36.5 | 22 | 67 | |
| 1JO-08-10 | 3/4" X16UNF | 7/8" X14UNF | 16.7 | 12.7 | 40.7 | 27 | 103 | |
| 1JO-08-12 | 3/4" X16UNF | 1.1/16" X12UN | 16.7 | 15 | 44.7 | 32 | 153 | |
| 1JO-10 | 7/8" X14UNF | 7/8" X14UNF | 19.3 | 12.7 | 43.2 | 27 | 114 | |
| 1JO-10-08 | 7/8" X14UNF | 3/4" X16UNF | 19.3 | 11 | 41.7 | 24 | 99 | |
| 1JO-10-12 | 7/8" X14UNF | 1.1/16" X12UN | 19.3 | 15 | 47.2 | 32 | 162 | |
| 1JO-12 | 1.1/16" X12UN | 1.1/16" X12UN | 21.9 | 15 | 50 | 32 | 187 | |
| 1JO-12-08 | 1.1/16" X12UN | 3/4" X16UNF | 21.9 | 11.13 | 49.2 | 27 | 157 | |
| 1JO-12-10 | 1.1/16" X12UN | 7/8" X14UNF | 21.9 | 12.7 | 47.7 | 27 | 147 | |
| 1JO-12-14 | 1.1/16" X12UN | 1.3/16" X12UN | 21.9 | 15.1 | 49 | 36 | 211 | |
| 1JO-12-16 | 1.1/16" X12UN | 1.5/16" X12UN | 21.9 | 15.09 | 50.5 | 38 | 237 | |
| 1JO-14 | 1.3/16" X12UN | 1.3/16" X12UN | 22.6 | 15.09 | 50.5 | 36 | 234 | |
| 1JO-14-12 | 1.3/16" X12UN | 1.1/16" X12UN | 22.6 | 15.09 | 49.5 | 32 | 198 | |
| 1JO-14-16 | 1.3/16" X12UN | 1.5/16" X12UN | 22.6 | 15.09 | 51.3 | 38 | 310 | |
| 1JO-16 | 1.5/16" X12UN | 1.5/16" X12UN | 23.1 | 15.09 | 51.8 | 38 | 267 | |
| 1JO-16-12 | 1.5/16" X12UN | 1.1/16" X12UN | 23.1 | 15.09 | 50.5 | 36 | 237 | |
| 1JO-16-14 | 1.5/16" X12UN | 1.3/16" X12UN | 23.1 | 15.09 | 52 | 36 | 254 | |
| 1JO-16-20 | 1.5/16" X12UN | 1.5/8" X12UN | 23.1 | 15.09 | 54.1 | 50 | 407 | |
| 1JO-20 | 1.5/8" X12UN | 1.5/8" X12UN | 24.3 | 15.1 | 55.1 | 50 | 451 | |
| 1JO-20-16 | 1.5/8" X12UN | 1.5/16" X12UN | 24.3 | 15.1 | 59.1 | 46 | 446 | |
| 1JO-20-24 | 1.5/8" X12UN | 1.7/8" X12UN | 24.3 | 15.1 | 54.5 | 55 | 494 | |
| 1JO-24 | 1.7/8" X12UN | 1.7/8" X12UN | 27.5 | 15.09 | 60.2 | 55 | 577 | |
| 1JO-24-20 | 1.7/8" X12UN | 1.5/8" X12UN | 27.5 | 15.09 | 62 | 50 | 548 | |
| 1JO-24-32 | 1.7/8" X12UN | 2.1/2" X12UN | 27.5 | 15.09 | 62 | 70 | 857 | |
| 1JO-32 | 2.1/2" X12UN | 2.1/2" X12UN | 34 | 15 | 71 | 70 | 1141 | |

AJOJ-OG

美制JIC外螺纹74°外锥/SAE外螺纹带O形圈轻系列ISO 11926-3分支三通
JIC MALE 74° CONE/SAE O-RING BOSS L-SERIES ISO 11926-3 BRANCH TEE

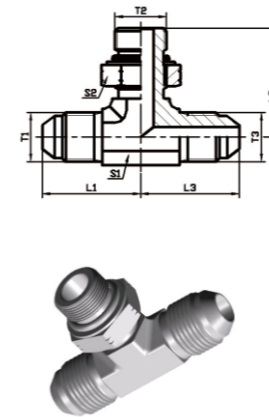

| 产品代号 PART NO. | 螺纹 THREAD | | | 尺寸 DIMENSIONS | | | | 重量 (g) | 压力等级 MPa | |
|------------------|---------------|---------------|---------------|---------------|------|------|----|-----------|-------------|------|
| | T1 | T2 | T3 | L1 | L2 | L3 | S1 | | | S2 |
| AJOJ-04OG | 7/16" X20UNF | 7/16" X20UNF | 7/16" X20UNF | 22.6 | 26.2 | 22.6 | 11 | 17 | 42 | 31.5 |
| AJOJ-05OG | 1/2" X20UNF | 1/2" X20UNF | 1/2" X20UNF | 24.1 | 28.7 | 24.1 | 14 | 17 | 56 | |
| AJOJ-06OG | 9/16" X18UNF | 9/16" X18UNF | 9/16" X18UNF | 26.9 | 31.8 | 26.9 | 14 | 19 | 74 | |
| AJOJ-08OG | 3/4" X16UNF | 3/4" X16UNF | 3/4" X16UNF | 31.8 | 36.8 | 31.8 | 19 | 24 | 157 | 31 |
| AJOJ-10OG | 7/8" X14UNF | 7/8" X14UNF | 7/8" X14UNF | 36.8 | 43.2 | 36.8 | 22 | 27 | 227 | 24 |
| AJOJ-12OG | 1.1/16" X12UN | 1.1/16" X12UN | 1.1/16" X12UN | 42.2 | 49.3 | 42.2 | 27 | 32 | 373 | |
| AJOJ-16OG | 1.5/16" X12UN | 1.5/16" X12UN | 1.5/16" X12UN | 46 | 52.1 | 46 | 33 | 41 | 569 | 20 |
| AJOJ-20OG | 1.5/8" X12UN | 1.5/8" X12UN | 1.5/8" X12UN | 52.3 | 57.2 | 52.3 | 41 | 50 | 922 | 16 |
| AJOJ-24OG | 1.7/8" X12UN | 1.7/8" X12UN | 1.7/8" X12UN | 59.2 | 60.7 | 59.2 | 48 | 55 | 1236 | 14 |

20J

SAE 外螺纹带O形圈轻系列/JIC内螺纹74°内锥
SAE O-RING BOSS L-SERIES / JIC FEMALE 74° SEAT

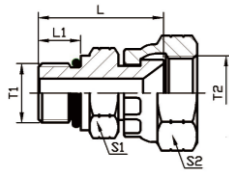

| 产品代号 PART NO. | 螺纹 THREAD | | 尺寸 DIMENSIONS | | | | 重量 (g) | 压力等级 MPa |
|------------------|--------------|--------------|---------------|------|----|----|-----------|-------------|
| | T1 | T2 | L1 | L | S1 | S2 | | |
| 20J-04 | 7/16"X20UNF | 7/16"X20UNF | 9.5 | 24.5 | 14 | 14 | 72 | 31.5 |
| 20J-06-04 | 9/16"X18UNF | 7/16"X20UNF | 11 | 26 | 17 | 17 | 100 | |
| 20J-05 | 1/2"X20UNF | 1/2"X20UNF | 9 | 25 | 17 | 17 | 74 | |
| 20J-06 | 9/16"X18UNF | 9/16"X18UNF | 9 | 26 | 17 | 19 | 101 | |
| 20J-04-06 | 7/16"X20UNF | 9/16"X18UNF | 7.5 | 24.5 | 14 | 19 | 80 | |
| 20J-08-06 | 3/4"X16UNF | 9/16"X18UNF | 10.5 | 27.5 | 22 | 19 | 167 | |
| 20J-08 | 3/4"X16UNF | 3/4"X16UNF | 11 | 30 | 22 | 22 | 206 | |
| 20J-06-08 | 9/16"X18UNF | 3/4"X16UNF | 9.5 | 28 | 19 | 22 | 145 | 31.5 |
| 20J-10-08 | 7/8"X14UNF | 3/4"X16UNF | 15.5 | 37 | 22 | 22 | 287 | |
| 20J-10 | 7/8"X14UNF | 7/8"X14UNF | 13 | 34 | 24 | 27 | 293 | 24 |
| 20J-08-10 | 3/4"X16UNF | 7/8"X14UNF | 9 | 29.5 | 22 | 27 | 223 | |
| 20J-12-10 | 1.1/16"X12UN | 7/8"X14UNF | 16.5 | 36 | 32 | 27 | 455 | 25 |
| 20J-12 | 1.1/16"X12UN | 1.1/16"X12UN | 13 | 37.5 | 32 | 32 | 425 | |
| 20J-10-12 | 7/8"X14UNF | 1.1/16"X12UN | 10.5 | 38.5 | 32 | 32 | 337 | 24 |
| 20J-16-12 | 1.5/16"X12UN | 1.1/16"X12UN | 18 | 42 | 38 | 32 | 676 | |
| 20J-16 | 1.5/16"X12UN | 1.5/16"X12UN | 15.5 | 42 | 38 | 41 | 664 | 20 |
| 20J-12-16 | 1.1/16"X12UN | 1.5/16"X12UN | 12 | 38.5 | 36 | 41 | 524 | |
| 20J-20 | 1.5/8"X12UN | 1.5/8"X12UN | 14 | 46.5 | 50 | 50 | 872 | 16 |

40

美制SAE外螺纹带O形圈堵头轻系列ISO 11926-3
SAE O-RING BOSS PLUG L-SERIES ISO 11926-3

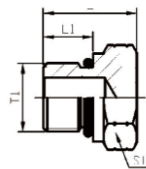

| 产品代号 PART NO. | 螺纹 THREAD | 尺寸 DIMENSIONS | | | 重量 (g) | 压力等级 MPa |
|------------------|--------------|---------------|------|----|--------|-------------|
| | T1 | L1 | L | S1 | | |
| 40-04 | 7/16"X20UNF | 9.14 | 17 | 14 | 16 | 31.5 |
| 40-05 | 1/2"X20UNF | 9.14 | 17 | 17 | 23 | |
| 40-06 | 9/16"X18UNF | 9.93 | 18.5 | 17 | 26 | |
| 40-08 | 3/4"X16UNF | 11.13 | 20.5 | 22 | 50 | 25 |
| 40-10 | 7/8"X14UNF | 12.7 | 23.6 | 27 | 81 | |
| 40-12 | 1.1/16"X12UN | 15.1 | 27.7 | 32 | 135 | |
| 40-14 | 1.3/16"X12UN | 15.1 | 27.7 | 36 | 165 | 20 |
| 40-16 | 1.5/16"X12UN | 15.1 | 28.5 | 38 | 198 | |
| 40-20 | 1.5/8"X12UN | 15.1 | 30.5 | 50 | 357 | 16 |
| 40-24 | 1.7/8"X12UN | 15 | 30 | 55 | 423 | |
| 40-32 | 2.1/2"X12UN | 15.1 | 36.3 | 70 | 910 | 12.5 |

1JO4-OG

45°弯美制JIC外螺纹74°外锥/SAE外螺纹带O形圈轻系列ISO 11926-3
45° ELBOW JIC MALE 74° CONE/SAE O-RING BOSS L-SERIES ISO 11926-3

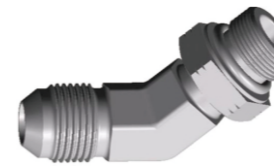
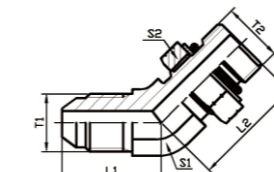

| 产品代号 PART NO. | 螺纹 THREAD | | 尺寸 DIMENSIONS | | | | 重量 (g) | 压力等级 MPa |
|------------------|--------------|--------------|---------------|------|----|----|-----------|-------------|
| | T1 | T2 | L1 | L2 | S1 | S2 | | |
| 1JO4-04OG | 7/16"X20UNF | 7/16"X20UNF | 20.6 | 24.7 | 11 | 17 | 27 | 31.5 |
| 1JO4-04-06OG | 7/16"X20UNF | 9/16"X18UNF | 21.1 | 29 | 17 | 19 | 37 | |
| 1JO4-04-08OG | 7/16"X20UNF | 3/4"X16UNF | 24.5 | 32.5 | 19 | 24 | 65 | |
| 1JO4-05OG | 1/2"X20UNF | 1/2"X20UNF | 19.6 | 26.7 | 14 | 17 | 33 | |
| 1JO4-05-04OG | 1/2"X20UNF | 7/16"X20UNF | 19.6 | 26.7 | 14 | 17 | 30 | |
| 1JO4-06OG | 9/16"X18UNF | 9/16"X18UNF | 21.1 | 29 | 14 | 19 | 43 | |
| 1JO4-06-04OG | 9/16"X18UNF | 7/16"X20UNF | 21.1 | 26.7 | 14 | 17 | 34 | |
| 1JO4-06-05OG | 9/16"X18UNF | 1/2"X20UNF | 21.1 | 26.7 | 17 | 17 | 37 | |
| 1JO4-06-08OG | 9/16"X18UNF | 3/4"X16UNF | 25 | 32.5 | 19 | 24 | 72 | 25 |
| 1JO4-06-10OG | 9/16"X18UNF | 7/8"X14UNF | 25.5 | 38.5 | 22 | 27 | 96 | |
| 1JO4-08OG | 3/4"X16UNF | 3/4"X16UNF | 25 | 33 | 19 | 24 | 90 | 31 |
| 1JO4-08-06OG | 3/4"X16UNF | 9/16"X18UNF | 25 | 28 | 19 | 19 | 63 | |
| 1JO4-08-10OG | 3/4"X16UNF | 7/8"X14UNF | 27.5 | 38.7 | 22 | 27 | 118 | 25 |
| 1JO4-08-12OG | 3/4"X16UNF | 1.1/16"X12UN | 30 | 43.9 | 27 | 32 | 170 | |
| 1JO4-10OG | 7/8"X14UNF | 7/8"X14UNF | 28.5 | 38.7 | 22 | 27 | 130 | 24 |
| 1JO4-10-08OG | 7/8"X14UNF | 3/4"X16UNF | 28.5 | 34.5 | 22 | 24 | 110 | |
| 1JO4-10-12OG | 7/8"X14UNF | 1.1/16"X12UN | 31 | 43.9 | 27 | 32 | 182 | |
| 1JO4-12OG | 1.1/16"X12UN | 1.1/16"X12UN | 32.5 | 43.9 | 27 | 32 | 213 | 20 |
| 1JO4-12-10OG | 1.1/16"X12UN | 7/8"X14UNF | 32.5 | 39.8 | 27 | 27 | 168 | |
| 1JO4-12-16OG | 1.1/16"X12UN | 1.5/16"X12UN | 37 | 45.5 | 33 | 41 | 283 | |
| 1JO4-14OG | 1.3/16"X12UN | 1.3/16"X12UN | 37 | 47.5 | 33 | 36 | 291 | 21 |
| 1JO4-16OG | 1.5/16"X12UN | 1.5/16"X12UN | 37.5 | 47.5 | 33 | 41 | 335 | |
| 1JO4-16-12OG | 1.5/16"X12UN | 1.1/16"X12UN | 37.5 | 45 | 33 | 32 | 273 | |
| 1JO4-16-20OG | 1.5/16"X12UN | 1.5/8"X12UN | 40.5 | 47 | 41 | 50 | 427 | 16 |
| 1JO4-20OG | 1.5/8"X12UN | 1.5/8"X12UN | 40.5 | 48.5 | 41 | 50 | 507 | |
| 1JO4-20-24OG | 1.5/8"X12UN | 1.7/8"X12UN | 45.5 | 50 | 48 | 55 | 605 | 14 |
| 1JO4-24OG | 1.7/8"X12UN | 1.7/8"X12UN | 45.5 | 48.5 | 48 | 55 | 649 | |
| 1JO4-32OG | 2.1/2"X12UN | 2.1/2"X12UN | 56.5 | 54 | 63 | 70 | 1338 | 10.5 |

AJJO-OG

美制JIC外螺纹74°外锥/SAE外螺纹带O形圈轻系列ISO 11926-3主支三通
JIC MALE 74° CONE/SAE O-RING BOSS L-SERIES ISO 11926-3 RUN TEE

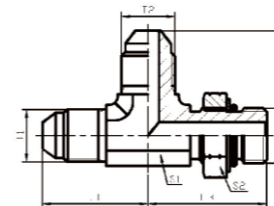

| 产品代号 PART NO. | 螺纹 THREAD | | | 尺寸 DIMENSIONS | | | | | 重量 (g) | 压力等级 MPa |
|------------------|--------------|--------------|--------------|---------------|------|------|----|----|-----------|-------------|
| | T1 | T2 | T3 | L1 | L2 | L3 | S1 | S2 | | |
| AJJO-04OG | 7/16"X20UNF | 7/16"X20UNF | 7/16"X20UNF | 22.6 | 22.6 | 26.2 | 11 | 17 | 43 | 31.5 |
| AJJO-05OG | 1/2"X20UNF | 1/2"X20UNF | 1/2"X20UNF | 24.1 | 24.1 | 28.7 | 14 | 17 | 56 | |
| AJJO-06OG | 9/16"X18UNF | 9/16"X18UNF | 9/16"X18UNF | 26.9 | 26.9 | 31.8 | 14 | 19 | 74 | |
| AJJO-08OG | 3/4"X16UNF | 3/4"X16UNF | 3/4"X16UNF | 31.8 | 31.8 | 36.8 | 19 | 24 | 157 | 31 |
| AJJO-10OG | 7/8"X14UNF | 7/8"X14UNF | 7/8"X14UNF | 36.8 | 36.8 | 43.2 | 22 | 27 | 226 | |
| AJJO-12OG | 1.1/16"X12UN | 1.1/16"X12UN | 1.1/16"X12UN | 42.2 | 42.2 | 49.3 | 27 | 32 | 373 | 24 |
| AJJO-16OG | 1.5/16"X12UN | 1.5/16"X12UN | 1.5/16"X12UN | 46 | 46 | 52.1 | 33 | 41 | 569 | |
| AJJO-20OG | 1.5/8"X12UN | 1.5/8"X12UN | 1.5/8"X12UN | 52.3 | 52.3 | 57.2 | 41 | 50 | 923 | 20 |
| AJJO-24OG | 1.7/8"X12UN | 1.7/8"X12UN | 1.7/8"X12UN | 59.2 | 59.2 | 60.7 | 48 | 55 | 1236 | |

1J09-OG

90°弯美制JIC外螺纹74°外锥/SAE外螺纹带O形圈轻系列ISO 11926-3
90° ELBOW JIC MALE 74° CONE/SAE O-RING BOSS L-SERIES ISO 11926-3

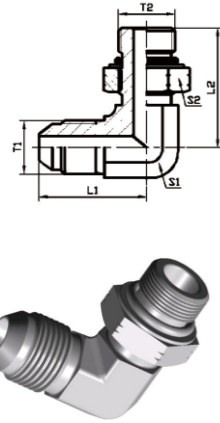

| 产品代号 PART NO. | 螺纹 THREAD | | 尺寸 DIMENSIONS | | | | 重量 (g) | 压力等级 MPa |
|------------------|---------------|---------------|---------------|------|----|----|-----------|-------------|
| | T1 | T2 | L1 | L2 | S1 | S2 | | |
| 1J09-04OG | 7/16" X20UNF | 7/16" X20UNF | 22.6 | 26.2 | 11 | 17 | 29 | 31.5 |
| 1J09-04-05OG | 7/16" X20UNF | 1/2" X20UNF | 24.1 | 28.7 | 14 | 17 | 35 | |
| 1J09-04-06OG | 7/16" X20UNF | 9/16" X18UNF | 24.1 | 29.3 | 14 | 19 | 40 | |
| 1J09-05-04OG | 1/2" X20UNF | 7/16" X20UNF | 24.1 | 28.7 | 14 | 17 | 35 | |
| 1J09-05OG | 1/2" X20UNF | 1/2" X20UNF | 24.1 | 28.7 | 14 | 17 | 38 | |
| 1J09-05-06OG | 1/2" X20UNF | 9/16" X18UNF | 24.5 | 31.8 | 14 | 19 | 45 | |
| 1J09-06-04OG | 9/16" X18UNF | 7/16" X20UNF | 26.9 | 31.2 | 14 | 17 | 42 | |
| 1J09-06-05OG | 9/16" X18UNF | 1/2" X20UNF | 26.9 | 31.2 | 14 | 17 | 45 | |
| 1J09-06OG | 9/16" X18UNF | 9/16" X18UNF | 26.9 | 31.8 | 14 | 19 | 50 | |
| 1J09-06-08OG | 9/16" X18UNF | 3/4" X16UNF | 29 | 36.8 | 19 | 24 | 82 | |
| 1J09-08-04OG | 3/4" X16UNF | 7/16" X18 | 32 | 33 | 19 | 17 | 70 | |
| 1J09-08-06OG | 3/4" X16UNF | 9/16" X18UNF | 32 | 33.5 | 19 | 19 | 79 | |
| 1J09-08OG | 3/4" X16UNF | 3/4" X16UNF | 31.8 | 36.8 | 19 | 24 | 107 | |
| 1J09-08-10OG | 3/4" X16UNF | 7/8" X14UNF | 34 | 43.5 | 22 | 27 | 137 | |
| 1J09-08-12OG | 3/4" X16UNF | 1.1/16" X12UN | 36.5 | 49.5 | 27 | 32 | 195 | |
| 1J09-10-08OG | 7/8" X14UNF | 3/4" X16UNF | 38 | 40 | 22 | 24 | 136 | |
| 1J09-10OG | 7/8" X14UNF | 7/8" X14UNF | 36.8 | 43.2 | 22 | 27 | 155 | |
| 1J09-10-12OG | 7/8" X14UNF | 1.1/16" X12UN | 41 | 51 | 27 | 32 | 222 | |
| 1J09-12-08OG | 1.1/16" X12UN | 3/4" X16UNF | 42.2 | 44 | 27 | 24 | 186 | |
| 1J09-12-10OG | 1.1/16" X12UN | 7/8" X14UNF | 42.2 | 47 | 27 | 27 | 210 | |
| 1J09-12OG | 1.1/16" X12UN | 1.1/16" X12UN | 42.2 | 49.3 | 27 | 32 | 255 | |
| 1J09-12-16OG | 1.1/16" X12UN | 1.5/16" X12UN | 47.8 | 54.5 | 33 | 41 | 348 | |
| 1J09-14OG | 1.3/16" X12UN | 1.3/16" X12UN | 45.7 | 51 | 30 | 36 | 333 | |
| 1J09-14-16OG | 1.3/16" X12UN | 1.5/16" X12UN | 45.7 | 54.5 | 33 | 41 | 372 | |
| 1J09-16-12OG | 1.5/16" X12UN | 1.1/16" X12UN | 45.7 | 54.5 | 33 | 32 | 332 | |
| 1J09-16-14OG | 1.5/16" X12UN | 1.3/16" X12UN | 46 | 56 | 33 | 36 | 375 | |
| 1J09-16OG | 1.5/16" X12UN | 1.5/16" X12UN | 46 | 52.1 | 33 | 41 | 387 | |
| 1J09-16-20OG | 1.5/16" X12UN | 1.5/8" X12UN | 52.3 | 59 | 41 | 50 | 542 | |
| 1J09-20-16OG | 1.5/8" X12UN | 1.5/16" X12UN | 52.3 | 57.2 | 41 | 41 | 524 | |
| 1J09-20OG | 1.5/8" X12UN | 1.5/8" X12UN | 52.3 | 57.2 | 41 | 50 | 624 | |
| 1J09-20-24OG | 1.5/8" X12UN | 1.7/8" X12UN | 56 | 60.7 | 48 | 55 | 750 | |
| 1J09-24OG | 1.7/8" X12UN | 1.7/8" X12UN | 59.2 | 60.7 | 48 | 55 | 828 | |
| 1J09-32OG | 2.1/2" X12UN | 2.1/2" X12UN | 77.7 | 73.4 | 63 | 70 | 1830 | |

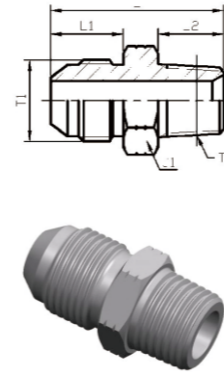

1JN

美制JIC外螺纹74°外锥/布锥外管螺纹
JIC MALE 74° CONE/NPT MALE

| 产品代号 PART NO. | 螺纹 THREAD | | 尺寸 DIMENSIONS | | | | 重量 (g) | 压力等级 MPa |
|------------------|---------------|---------------|---------------|------|------|----|-----------|-------------|
| | T1 | T2 | L1 | L2 | L | S1 | | |
| 1JN-04-02 | 7/16" X20UNF | Z1/8" X27 | 14 | 10.5 | 31 | 12 | 20 | 34.5 |
| 1JN-04 | 7/16" X20UNF | Z1/4" X18 | 14 | 15 | 36 | 17 | 33 | 27.5 |
| 1JN-04-06 | 7/16" X20UNF | Z3/8" X18 | 14 | 16 | 36 | 19 | 42 | 21 |
| 1JN-04-08 | 7/16" X20UNF | Z1/2" X14 | 14 | 19.5 | 43 | 24 | 80 | 27.5 |
| 1JN-05-04 | 1/2" X20UNF | Z1/4" X18 | 14 | 15 | 36 | 17 | 35 | 21 |
| 1JN-05-06 | 1/2" X20UNF | Z3/8" X18 | 14 | 16 | 37 | 19 | 46 | |
| 1JN-05-08 | 1/2" X20UNF | Z1/2" X14 | 14 | 19.5 | 43 | 24 | 81 | |
| 1JN-06-04 | 9/16" X18UNF | Z1/4" X18 | 14.1 | 15 | 36.5 | 17 | 36 | 27.5 |
| 1JN-06 | 9/16" X18UNF | Z3/8" X18 | 14.1 | 16 | 36.5 | 19 | 45 | 21 |
| 1JN-06-08 | 9/16" X18UNF | Z1/2" X14 | 14.1 | 19.5 | 42.9 | 24 | 79 | |
| 1JN-08-04 | 3/4" X16UNF | Z1/4" X18 | 16.7 | 15 | 39 | 22 | 60 | 27.5 |
| 1JN-08-06 | 3/4" X16UNF | Z3/8" X18 | 16.7 | 16 | 39 | 22 | 64 | 21 |
| 1JN-08 | 3/4" X16UNF | Z1/2" X14 | 16.7 | 19.5 | 44 | 24 | 87 | |
| 1JN-08-12 | 3/4" X16UNF | Z3/4" X14 | 16.7 | 19.5 | 47 | 30 | 135 | 17 |
| 1JN-10-06 | 7/8" X14UNF | Z3/8" X18 | 19.3 | 16 | 43.5 | 24 | 86 | 21 |
| 1JN-10-08 | 7/8" X14UNF | Z1/2" X14 | 19.3 | 19.5 | 48 | 24 | 100 | |
| 1JN-10-12 | 7/8" X14UNF | Z3/4" X14 | 19.3 | 19.5 | 49.5 | 30 | 137 | 17 |
| 1JN-12-08 | 1.1/16" X12UN | Z1/2" X14 | 21.9 | 19.5 | 52.3 | 30 | 153 | 21 |
| 1JN-12 | 1.1/16" X12UN | Z3/4" X14 | 21.9 | 19.5 | 52.3 | 30 | 159 | 17 |
| 1JN-12-16 | 1.1/16" X12UN | Z1" X11.5 | 21.9 | 25.5 | 57.1 | 36 | 229 | 14 |
| 1JN-12-20 | 1.1/16" X12UN | Z1.1/4" X11.5 | 21.9 | 26.5 | 61.5 | 46 | 386 | 8 |
| 1JN-14-12 | 1.3/16" X12UN | Z3/4" X14 | 22.6 | 19.5 | 53 | 32 | 184 | |
| 1JN-16-12 | 1.5/16" X12UN | Z3/4" X14 | 23.1 | 19.5 | 53.5 | 36 | 222 | 17 |
| 1JN-16 | 1.5/16" X12UN | Z1" X11.5 | 23.1 | 25.5 | 58.5 | 36 | 260 | 14 |
| 1JN-16-20 | 1.5/16" X12UN | Z1.1/4" X11.5 | 23.1 | 26.5 | 62.5 | 46 | 398 | 8 |
| 1JN-16-24 | 1.5/16" X12UN | Z1.1/2" X11.5 | 23.1 | 27.5 | 65.5 | 50 | 504 | |
| 1JN-20-16 | 1.5/8" X12UN | Z1" X11.5 | 24.3 | 25.5 | 61.5 | 46 | 369 | 14 |
| 1JN-20 | 1.5/8" X12UN | Z1.1/4" X11.5 | 24.3 | 26.5 | 62.2 | 46 | 416 | 8 |
| 1JN-20-24 | 1.5/8" X12UN | Z1.1/2" X11.5 | 24.3 | 27.5 | 67 | 50 | 530 | 7 |
| 1JN-24-20 | 1.7/8" X12UN | Z1.1/4" X11.5 | 27.5 | 26.5 | 67.3 | 50 | 512 | 8 |
| 1JN-24 | 1.7/8" X12UN | Z1.1/2" X11.5 | 27.5 | 27.5 | 68 | 50 | 540 | 7 |
| 1JN-24-32 | 1.7/8" X12UN | Z2" X11.5 | 27.5 | 27.5 | 72 | 65 | 805 | 7 |
| 1JN-32 | 2.1/2" X12UN | Z2" X11.5 | 33.9 | 27.5 | 79 | 65 | 973 | |
| 1JN-32-24 | 2.1/2" X12UN | Z1.1/2" X11.5 | 33.9 | 27.5 | 78.5 | 65 | 1003 | |

1JH

美制JIC外螺纹74°外锥/公制外螺纹轻系列ISO 6149-3
JIC MALE 74° CONE/METRIC MALE END L-SERIES ISO 6149-3

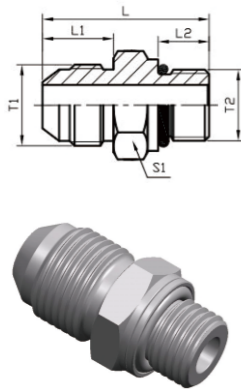

| 产品代号 PART NO. | 螺纹 THREAD | | 尺寸 DIMENSIONS | | | | 重量 (g) | 压力等级 MPa |
|------------------|---------------|---------|---------------|------|------|----|-----------|-------------|
| | T1 | T2 | L1 | L2 | L | S1 | | |
| 1JH-04-10 | 7/16" X20UNF | M10X1 | 14 | 8.5 | 31 | 14 | 21 | 34.5 |
| 1JH-05-12 | 1/2" X20UNF | M12X1.5 | 14 | 11 | 33.5 | 17 | 30 | |
| 1JH-06-14 | 9/16" X18UNF | M14X1.5 | 14.1 | 11 | 33.5 | 19 | 36 | |
| 1JH-06-16 | 9/16" X18UNF | M16X1.5 | 14.1 | 11.5 | 35.1 | 22 | 52 | |
| 1JH-08-16 | 3/4" X16UNF | M16X1.5 | 16.7 | 11.5 | 37.6 | 22 | 67 | 31.5 |
| 1JH-08-18 | 3/4" X16UNF | M18X1.5 | 16.7 | 12.5 | 39.1 | 24 | 74 | |
| 1JH-10-18 | 7/8" X14UNF | M18X1.5 | 19.3 | 12.5 | 41.7 | 24 | 88 | |
| 1JH-10-22 | 7/8" X14UNF | M22X1.5 | 19.3 | 13 | 42.9 | 27 | 108 | |
| 1JH-12-22 | 1.1/16" X12UN | M22X1.5 | 21.9 | 13 | 45.5 | 27 | 160 | 20 |
| 1JH-12-27 | 1.1/16" X12UN | M27X2 | 21.9 | 16 | 49 | 32 | 180 | |
| 1JH-16-27 | 1.5/16" X12UN | M27X2 | 23.1 | 16 | 50.5 | 36 | 247 | |
| 1JH-16-33 | 1.5/16" X12UN | M33X2 | 23.1 | 16 | 51.6 | 41 | 285 | |
| 1JH-20-42 | 1.5/8" X12UN | M42X2 | 24.3 | 16 | 54.9 | 50 | 488 | 17 |
| 1JH-24-48 | 1.7/8" X12UN | M48X2 | 27.5 | 17.5 | 59.4 | 55 | 605 | 14 |

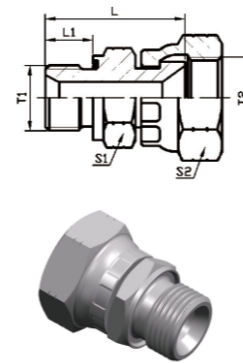

2MJ-WD

公制螺纹胶垫密封/JIC内螺纹74°内锥
METRIC THREAD MALE CAPTIVE SEAL/JIC FEMALE 74° SEAT

| 产品代号 PART NO. | 螺纹 THREAD | | 尺寸 DIMENSIONS | | | | 重量 (g) | 压力等级 MPa |
|------------------|-----------|---------------|---------------|------|----|----|-----------|-------------|
| | T1 | T2 | L1 | L | S1 | S2 | | |
| 2MJ-10-04WD | M10X1 | 7/16" X20UNF | 8 | 24 | 14 | 14 | 59 | 34.5 |
| 2MJ-12-05WD | M12X1.5 | 1/2" X20UNF | 12 | 28.8 | 17 | 17 | 72 | |
| 2MJ-14-06WD | M14X1.5 | 9/16" X18UNF | 12 | 30.4 | 19 | 19 | 120 | 31 |
| 2MJ-16-08WD | M16X1.5 | 3/4" X16UNF | 12 | 33.5 | 22 | 22 | 168 | |
| 2MJ-22-08WD | M22X1.5 | 7/8" X14UNF | 14 | 37.6 | 27 | 27 | 305 | 24 |
| 2MJ-27-12WD | M27X2.0 | 1.1/16" X12UN | 16 | 41.5 | 32 | 32 | 481 | |
| 2MJ-33-16WD | M33X2.0 | 1.5/16" X12UN | 18 | 45.2 | 41 | 41 | 733 | 21 |

1JN4

45°弯美制JIC外螺纹74°外锥/布锥管外螺纹
45°ELBOW JIC MALE 74° CONE/NPT MALE

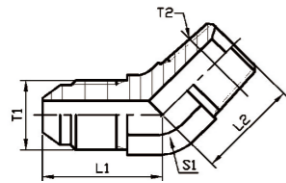

| 产品代号 PART NO. | 螺纹 THREAD | | 尺寸 DIMENSIONS | | | 重量 (g) | 压力等级 MPa |
|------------------|--------------|--------------|---------------|------|----|-----------|-------------|
| | T1 | T2 | L1 | L2 | S1 | | |
| 1JN4-04-02 | 7/16"X20UNF | Z1/8"X27 | 18.3 | 16.5 | 11 | 18 | 34.5 |
| 1JN4-04 | 7/16"X20UNF | Z1/4"X18 | 22 | 21 | 14 | 28 | 27.5 |
| 1JN4-04-06 | 7/16"X20UNF | Z3/8"X18 | 23 | 24 | 19 | 41 | 21 |
| 1JN4-04-08 | 7/16"X20UNF | Z1/2"X14 | 24.5 | 29.5 | 22 | 68 | |
| 1JN4-05-02 | 1/2"X20UNF | Z1/8"X27 | 19.6 | 16.5 | 14 | 22 | 34.5 |
| 1JN4-05-04 | 1/2"X20UNF | Z1/4"X18 | 22 | 21 | 14 | 31 | 27.5 |
| 1JN4-06-02 | 9/16"X18UNF | Z1/8"X27 | 22 | 17.3 | 14 | 28 | 34.5 |
| 1JN4-06-04 | 9/16"X18UNF | Z1/4"X18 | 22.8 | 21 | 14 | 35 | 27.5 |
| 1JN4-06 | 9/16"X18UNF | Z3/8"X18 | 22 | 24 | 19 | 45 | 21 |
| 1JN4-06-08 | 9/16"X18UNF | Z1/2"X14 | 22.5 | 29.5 | 22 | 70 | |
| 1JN4-08-04 | 3/4"X16UNF | Z1/4"X18 | 25 | 24 | 19 | 56 | 27.5 |
| 1JN4-08-06 | 3/4"X16UNF | Z3/8"X18 | 24.9 | 24.1 | 19 | 65 | 21 |
| 1JN4-08 | 3/4"X16UNF | Z1/2"X14 | 25 | 29.5 | 22 | 45 | |
| 1JN4-08-12 | 3/4"X16UNF | Z3/4"X14 | 26.5 | 30.5 | 27 | 118 | 17 |
| 1JN4-10-08 | 7/8"X14UNF | Z1/2"X14 | 28.2 | 29.7 | 22 | 101 | 21 |
| 1JN4-10-12 | 7/8"X14UNF | Z3/4"X14 | 29.5 | 30.5 | 27 | 130 | 17 |
| 1JN4-12-08 | 1.1/16"X12UN | Z1/2"X14 | 32.5 | 31 | 27 | 141 | 21 |
| 1JN4-12 | 1.1/16"X12UN | Z3/4"X14 | 32.5 | 30.5 | 27 | 162 | 17 |
| 1JN4-12-16 | 1.1/16"X12UN | Z1"X11.5 | 37.5 | 39 | 33 | 244 | 14 |
| 1JN4-14-12 | 1.3/16"X12UN | Z3/4"X14 | 37 | 33 | 30 | 198 | 17 |
| 1JN4-16-12 | 1.5/16"X12UN | Z3/4"X14 | 38.5 | 36.5 | 33 | 240 | |
| 1JN4-16 | 1.5/16"X12UN | Z1"X11.5 | 37.3 | 37.6 | 33 | 285 | 14 |
| 1JN4-16-20 | 1.5/16"X12UN | Z1.1/4"X11.5 | 42 | 42.5 | 41 | 402 | 8 |
| 1JN4-20-16 | 1.5/8"X12UN | Z1"X11.5 | 43 | 42.5 | 41 | 395 | 14 |
| 1JN4-20 | 1.5/8"X12UN | Z1.1/4"X11.5 | 40.5 | 42.5 | 41 | 462 | 8 |
| 1JN4-20-24 | 1.5/8"X12UN | Z1.1/2"X11.5 | 46 | 45 | 48 | 570 | 7 |
| 1JN4-24 | 1.7/8"X12UN | Z1.1/2"X11.5 | 45.2 | 45 | 48 | 617 | |
| 1JN4-32 | 2.1/2"X12UN | Z2"X11.5 | 56.4 | 53.6 | 63 | 1182 | |

2HJ

公制外螺纹轻系列ISO 6149-3/JIC内螺纹74°内锥
METRIC MALE END L-SERIES ISO 6149-3/JIC FEMALE 74° SEAT

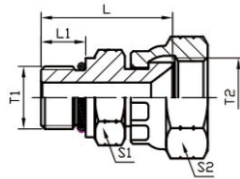

| 产品代号 PART NO. | 螺纹 THREAD | | 尺寸 DIMENSIONS | | | | 重量 (g) | 压力等级 MPa |
|------------------|-----------|--------------|---------------|------|----|----|--------|-------------|
| | T1 | T2 | L1 | L | S1 | S2 | | |
| 2HJ-10-04 | M10X1 | 7/16"X20UNF | 8.5 | 16.4 | 14 | 14 | 56 | 34.5 |
| 2HJ-12-05 | M12X1.5 | 1/2"X20UNF | 11 | 20.8 | 17 | 17 | 75 | |
| 2HJ-14-06 | M14X1.5 | 9/16"X18UNF | 11 | 21.4 | 19 | 19 | 113 | |
| 2HJ-16-08 | M16X1.5 | 3/4"X16UNF | 11.5 | 22.8 | 22 | 24 | 170 | 31 |
| 2HJ-22-08 | M22X1.5 | 7/8"X14UNF | 13 | 22.8 | 27 | 24 | 306 | 24 |
| 2HJ-27-12 | M27X2.0 | 1.1/16"X12UN | 16 | 23.4 | 32 | 32 | 521 | 20 |
| 2HJ-33-16 | M33X2.0 | 1.5/16"X12UN | 16 | 57.5 | 41 | 41 | 570 | |

1JN9

90°弯美制JIC外螺纹74°外锥/布锥管外螺纹
90°ELBOW JIC MALE 74° CONE/NPT MALE

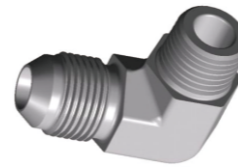
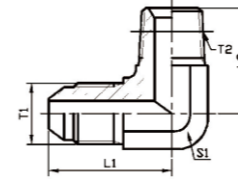

| 产品代号 PART NO. | 螺纹 THREAD | | 尺寸 DIMENSIONS | | | 重量 (g) | 压力等级 MPa |
|------------------|--------------|--------------|---------------|------|----|-----------|-------------|
| | T1 | T2 | L1 | L2 | S1 | | |
| 1JN9-04 | 7/16"X20UNF | Z1/4"X18 | 26.6 | 27.7 | 14 | 35 | 27.5 |
| 1JN9-04-02 | 7/16"X20UNF | Z1/8"X27 | 23 | 20.5 | 11 | 23 | 34.5 |
| 1JN9-04-06 | 7/16"X20UNF | Z3/8"X18 | 29 | 31 | 19 | 51 | 21 |
| 1JN9-05-04 | 1/2"X20UNF | Z1/4"X18 | 24.5 | 27.7 | 14 | 38 | 27.5 |
| 1JN9-05-06 | 1/2"X20UNF | Z3/8"X18 | 29 | 31 | 17 | 55 | 21 |
| 1JN9-06 | 9/16"X18UNF | Z3/8"X18 | 29 | 31 | 17 | 59 | |
| 1JN9-06-04 | 9/16"X18UNF | Z1/4"X18 | 26.9 | 27.7 | 14 | 43 | 27.5 |
| 1JN9-06-08 | 9/16"X18UNF | Z1/2"X14 | 31 | 37.3 | 22 | 85 | |
| 1JN9-08 | 3/4"X16UNF | Z1/2"X14 | 34.8 | 37.3 | 22 | 114 | 21 |
| 1JN9-08-04 | 3/4"X16UNF | Z1/4"X18 | 32 | 31 | 19 | 71 | 27.5 |
| 1JN9-08-06 | 3/4"X16UNF | Z3/8"X18 | 32 | 31 | 19 | 84 | 21 |
| 1JN9-08-12 | 3/4"X16UNF | Z3/4"X14 | 36.1 | 40.4 | 27 | 151 | 17 |
| 1JN9-10-06 | 7/8"X14UNF | Z3/8"X18 | 37 | 32.5 | 22 | 107 | 21 |
| 1JN9-10-08 | 7/8"X14UNF | Z1/2"X14 | 37 | 37.3 | 22 | 130 | |
| 1JN9-10-12 | 7/8"X14UNF | Z3/4"X14 | 39.2 | 40.4 | 27 | 170 | 17 |
| 1JN9-10-16 | 7/8"X14UNF | Z1"X11.5 | 44.5 | 50 | 33 | 259 | 14 |
| 1JN9-12 | 1.1/16"X12UN | Z3/4"X14 | 42.5 | 40.5 | 27 | 214 | 17 |
| 1JN9-12-08 | 1.1/16"X12UN | Z1/2"X14 | 42.5 | 40.4 | 27 | 182 | 21 |
| 1JN9-12-16 | 1.1/16"X12UN | Z1"X11.5 | 45 | 50 | 33 | 298 | 14 |
| 1JN9-12-20 | 1.1/16"X12UN | Z1.1/4"X11.5 | 52.5 | 54.5 | 41 | 442 | 8 |
| 1JN9-14-12 | 1.3/16"X12UN | Z3/4"X14 | 46 | 43 | 30 | 250 | 17 |
| 1JN9-14-16 | 1.3/16"X12UN | Z1"X11.5 | 48.7 | 50 | 33 | 330 | 14 |
| 1JN9-16 | 1.5/16"X12UN | Z1"X11.5 | 46 | 50 | 33 | 354 | |
| 1JN9-16-12 | 1.5/16"X12UN | Z3/4"X14 | 46 | 45.2 | 33 | 287 | 17 |
| 1JN9-16-20 | 1.5/16"X12UN | Z1.1/4"X11.5 | 54 | 60.5 | 41 | 541 | 8 |
| 1JN9-16-24 | 1.5/16"X12UN | Z1.1/2"X11.5 | 59.4 | 59.5 | 48 | 637 | 7 |
| 1JN9-20 | 1.5/8"X12UN | Z1.1/4"X11.5 | 52.3 | 60.5 | 41 | 626 | 8 |
| 1JN9-20-16 | 1.5/8"X12UN | Z1"X11.5 | 53 | 59.5 | 41 | 507 | 14 |
| 1JN9-20-24 | 1.5/8"X12UN | Z1.1/2"X11.5 | 56 | 67 | 48 | 774 | 7 |
| 1JN9-24 | 1.7/8"X12UN | Z1.1/2"X11.5 | 62.5 | 63 | 48 | 858 | |
| 1JN9-24-20 | 1.7/8"X12UN | Z1.1/4"X11.5 | 59 | 57 | 48 | 717 | 8 |
| 1JN9-32-24 | 2.1/2"X12UN | Z1.1/2"X11.5 | 77.7 | 70 | 63 | 1415 | 7 |
| 1JN9-32 | 2.1/2"X12UN | Z2"X11.5 | 77.7 | 76.2 | 63 | 1615 | |

1JT

美制JIC外螺纹74°外锥/英锥管外螺纹
JIC MALE 74° CONE/BSPT MALE

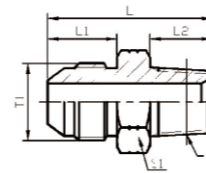

| 产品代号 PART NO. | 螺纹 THREAD | | 尺寸 DIMENSIONS | | | | 重量 (g) | 压力等级 MPa |
|------------------|--------------|------------|---------------|----|------|----|-----------|-------------|
| | T1 | T2 | L1 | L2 | L | S1 | | |
| 1JT-04-02SP | 7/16"X20UNF | R1/8"X28 | 14 | 10 | 31 | 12 | 22 | 34.5 |
| 1JT-04SP | 7/16"X20UNF | R1/4"X19 | 14 | 12 | 36 | 14 | 33 | |
| 1JT-05-02SP | 1/2"X20UNF | R1/8"X28 | 14 | 10 | 31 | 14 | 24 | |
| 1JT-05-04SP | 1/2"X20UNF | R1/4"X19 | 14 | 12 | 36 | 14 | 30 | |
| 1JT-06-04SP | 9/16"X18UNF | R1/4"X19 | 14.1 | 12 | 36.3 | 17 | 35 | |
| 1JT-06SP | 9/16"X18UNF | R3/8"X19 | 14.1 | 12 | 36.4 | 19 | 50 | |
| 1JT-08-04SP | 3/4"X16UNF | R1/4"X19 | 16.7 | 12 | 38.9 | 22 | 56 | 31 |
| 1JT-08-06SP | 3/4"X16UNF | R3/8"X19 | 16.7 | 12 | 38.9 | 22 | 61 | |
| 1JT-08SP | 3/4"X16UNF | R1/2"X14 | 16.7 | 14 | 45.5 | 22 | 98 | |
| 1JT-10-06SP | 7/8"X14UNF | R3/8"X19 | 19.3 | 12 | 43.2 | 24 | 89 | 24 |
| 1JT-10-08SP | 7/8"X14UNF | R1/2"X14 | 19.3 | 14 | 48 | 24 | 104 | |
| 1JT-10-12SP | 7/8"X14UNF | R3/4"X14 | 19.3 | 16 | 49.5 | 27 | 140 | |
| 1JT-12-08SP | 1.1/16"X12UN | R1/2"X14 | 21.9 | 14 | 52.3 | 27 | 145 | |
| 1JT-12SP | 1.1/16"X12UN | R3/4"X14 | 21.9 | 16 | 52.3 | 27 | 164 | |
| 1JT-12-16SP | 1.1/16"X12UN | R1"X11 | 21.9 | 18 | 57.1 | 36 | 248 | |
| 1JT-16-12SP | 1.5/16"X12UN | R3/4"X14 | 23.1 | 16 | 53.6 | 36 | 234 | 21 |
| 1JT-16SP | 1.5/16"X12UN | R1"X11 | 23.1 | 18 | 58.4 | 36 | 275 | 20.5 |
| 1JT-20-16SP | 1.5/8"X12UN | R1"X11 | 24.3 | 18 | 61.4 | 46 | 392 | 17 |
| 1JT-20SP | 1.5/8"X12UN | R1.1/4"X11 | 24.3 | 20 | 62.2 | 46 | 447 | |
| 1JT-24SP | 1.7/8"X12UN | R1.1/2"X11 | 27.5 | 22 | 68.1 | 50 | 568 | |

1JFS

美制JIC外螺纹74°外螺纹/重系列法兰ISO6162-2
JIC MALE 74° CONE/S-SERIES FLANGE ISO 6162-2-

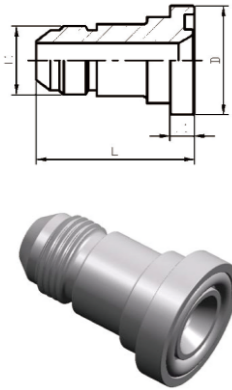

| 产品代号 PART NO. | 螺纹 THREAD | 法兰型号 FLANGESIZE | 尺寸 DIMENSIONS | | | 重量 (g) | 压力等级 MPa |
|------------------|---------------|--------------------|---------------|------|------|-----------|-------------|
| | T1 | | L1 | D | L | | |
| 1JFS-08 | 3/4" X16UNF | 1/2" | 7.75 | 31.7 | 47.5 | 70 | 31 |
| 1JFS-10-08 | 7/8" X14UNF | 1/2" | 7.75 | 31.7 | 50 | 90 | 24 |
| 1JFS-10-12 | 7/8" X14UNF | 3/4" | 8.76 | 41.3 | 55 | 99 | |
| 1JFS-12 | 1.1/16" X12UN | 3/4" | 8.76 | 41.3 | 56.7 | 146 | |
| 1JFS-12-16 | 1.1/16" X12UN | 1" | 9.53 | 47.6 | 61.5 | 158 | 21 |
| 1JFS-16-12 | 1.5/16" X12UN | 3/4" | 8.76 | 41.3 | 57.8 | 205 | |
| 1JFS-16 | 1.5/16" X12UN | 1" | 9.53 | 47.6 | 62.8 | 224 | 20 |
| 1JFS-16-20 | 1.5/16" X12UN | 1.1/4" | 10.29 | 54 | 67.7 | 241 | 17 |
| 1JFS-20-16 | 1.5/8" X12UN | 1" | 9.53 | 47.6 | 64 | 234 | |
| 1JFS-20 | 1.5/8" X12UN | 1.1/4" | 10.29 | 54 | 68.9 | 349 | |
| 1JFS-20-24 | 1.5/8" X12UN | 1.1/2" | 12.57 | 63.5 | 73.5 | 356 | 14 |
| 1JFS-24-20 | 1.7/8" X12UN | 1.1/4" | 10.29 | 54 | 72 | 432 | |
| 1JFS-24 | 1.7/8" X12UN | 1.1/2" | 12.57 | 63.5 | 76.7 | 438 | |

1JFS9

90°美制JIC外螺纹74°外螺纹/重系列法兰ISO 6162-2
90° JIC MALE 74° CONE/S-SERIES FLANGE ISO 6162-2

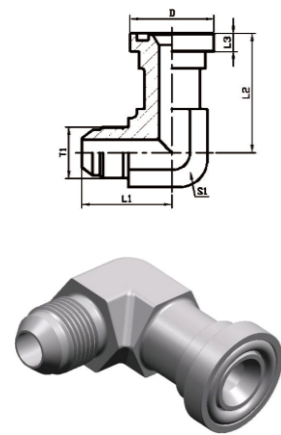

| 产品代号 PART NO. | 螺纹 THREAD | 法兰型号 FLANGESIZE | 尺寸 DIMENSIONS | | | | | 重量 (g) | 压力等级 MPa |
|------------------|---------------|--------------------|---------------|------|-------|------|----|--------|-------------|
| | T1 | | L1 | L2 | L3 | D | S1 | | |
| 1JFS9-08 | 3/4" X16UNF | 1/2" | 32.5 | 44 | 7.75 | 31.7 | 24 | 185 | 31 |
| 1JFS9-10-08 | 7/8" X14UNF | 1/2" | 37.5 | 46 | 7.75 | 31.7 | 24 | 202 | 24 |
| 1JFS9-10-12 | 7/8" X14UNF | 3/4" | 41 | 54.1 | 8.76 | 41.3 | 30 | 297 | |
| 1JFS9-12 | 1.1/16" X12UN | 3/4" | 44.2 | 54.1 | 8.76 | 41.3 | 27 | 326 | |
| 1JFS9-12-16 | 1.1/16" X12UN | 1" | 48 | 60.2 | 9.6 | 47.6 | 36 | 455 | 21 |
| 1JFS9-16 | 1.5/16" X12UN | 1" | 51.5 | 60.5 | 9.53 | 47.6 | 33 | 503 | |
| 1JFS9-16-12 | 1.5/16" X12UN | 3/4" | 49 | 57 | 8.76 | 41.3 | 30 | 386 | 17 |
| 1JFS9-16-20 | 1.5/16" X12UN | 1.1/4" | 54 | 66 | 10.29 | 54 | 41 | 634 | |
| 1JFS9-20 | 1.5/8" X12UN | 1.1/4" | 55.5 | 66.5 | 10.29 | 54 | 41 | 707 | |
| 1JFS9-20-16 | 1.5/8" X12UN | 1" | 55.5 | 65 | 9.53 | 47.6 | 41 | 605 | 14 |
| 1JFS9-20-24 | 1.5/8" X12UN | 1.1/2" | 59.5 | 79.3 | 12.57 | 63.5 | 48 | 1050 | |
| 1JFS9-24 | 1.7/8" X12UN | 1.1/2" | 62.5 | 79.3 | 12.57 | 63.5 | 48 | 1111 | |
| 1JFS9-24-20 | 1.7/8" X12UN | 1.1/4" | 62.5 | 70 | 10.29 | 54 | 48 | 810 | |

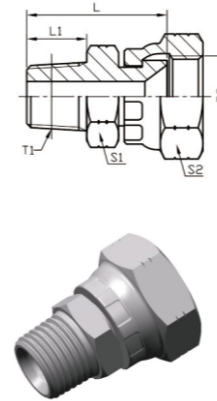

2TJ

英锥管外螺纹/JIC内螺纹74°内锥
BSPT MALE/JIC FEMALE 74° SEAT

| 产品代号 PART NO. | 螺纹 THREAD | | 尺寸 DIMENSIONS | | | | 重量 (g) | 压力等级 MPa |
|------------------|-------------|---------------|---------------|------|----|----|-----------|-------------|
| | T1 | T2 | L1 | L | S1 | S2 | | |
| 2TJ-04 | R1/4" X19 | 7/16" X20UNF | 12 | 29.1 | 14 | 14 | 88 | 34.5 |
| 2TJ-04-05 | R1/4" X19 | 1/2" X20UNF | 12 | 28.9 | 14 | 17 | 80 | |
| 2TJ-04-06 | R1/4" X19 | 9/16" X18UNF | 12 | 29.8 | 14 | 19 | 101 | |
| 2TJ-06 | R3/8" X19 | 9/16" X18UNF | 12 | 30.1 | 17 | 19 | 139 | 31 |
| 2TJ-04-08 | R1/4" X19 | 3/4" X16UNF | 12 | 31.8 | 19 | 24 | 143 | |
| 2TJ-06-08 | R3/8" X19 | 3/4" X16UNF | 12 | 31.8 | 19 | 24 | 170 | |
| 2TJ-08-10 | R1/2" X14 | 7/8" X14UNF | 14 | 38.2 | 22 | 27 | 255 | 24 |
| 2TJ-08-12 | R1/2" X14 | 1.1/16" X12UN | 14 | 39.6 | 27 | 32 | 318 | |
| 2TJ-12 | R3/4" X14 | 1.1/16" X12UN | 16 | 39.6 | 27 | 32 | 408 | 21 |
| 2TJ-12-16 | R3/4" X14 | 1.5/16" X12UN | 16 | 42.9 | 32 | 41 | 492 | |
| 2TJ-16 | R1" X11 | 1.5/16" X12UN | 18 | 47.8 | 36 | 41 | 624 | 20.5 |
| 2TJ-20 | R1.1/4" X11 | 1.5/8" X12UN | 20 | 52 | 46 | 50 | 1017 | 17 |

1JT9

90°弯美制JIC外螺纹74°外锥/英锥管外螺纹
90° ELBOW JIC MALE 74° CONE/BSPT MALE

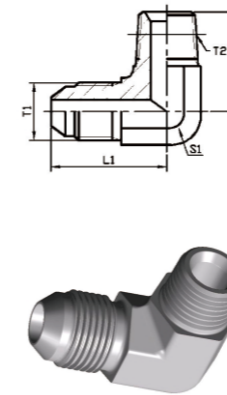

| 产品代号 PART NO. | 螺纹 THREAD | | 尺寸 DIMENSIONS | | | 重量 (g) | 压力等级 MPa |
|------------------|---------------|-------------|---------------|------|----|-----------|-------------|
| | T1 | T2 | L1 | L2 | S1 | | |
| 1JT9-04-02SP | 7/16" X20UNF | R1/8" X28 | 22.6 | 19.8 | 11 | 22 | 34.5 |
| 1JT9-04SP | 7/16" X20UNF | R1/4" X19 | 26.6 | 27.7 | 14 | 40 | |
| 1JT9-05-02SP | 1/2" X20UNF | R1/8" X28 | 24.1 | 19.8 | 14 | 22 | |
| 1JT9-05-04SP | 1/2" X20UNF | R1/4" X19 | 26.6 | 27.7 | 14 | 41 | 31 |
| 1JT9-06-04SP | 9/16" X18UNF | R1/4" X19 | 26.9 | 27.7 | 14 | 42 | |
| 1JT9-06SP | 9/16" X18UNF | R3/8" X19 | 29 | 31 | 17 | 65 | |
| 1JT9-06-08SP | 9/16" X18UNF | R1/2" X14 | 31 | 37.3 | 22 | 100 | 24 |
| 1JT9-08-04SP | 3/4" X16UNF | R1/4" X19 | 31.8 | 31 | 19 | 71 | |
| 1JT9-08-06SP | 3/4" X16UNF | R3/8" X19 | 31.8 | 31 | 19 | 83 | |
| 1JT9-08SP | 3/4" X16UNF | R1/2" X14 | 33.8 | 37.3 | 22 | 127 | 21 |
| 1JT9-10-06SP | 7/8" X14UNF | R3/8" X19 | 36.5 | 32.5 | 22 | 112 | |
| 1JT9-10-08SP | 7/8" X14UNF | R1/2" X14 | 36.8 | 37.3 | 22 | 132 | |
| 1JT9-10-12SP | 7/8" X14UNF | R3/4" X14 | 39.2 | 40.4 | 27 | 182 | 17 |
| 1JT9-12-08SP | 1.1/16" X12UN | R1/2" X14 | 42.2 | 40.4 | 27 | 198 | |
| 1JT9-12SP | 1.1/16" X12UN | R3/4" X14 | 42.2 | 40.4 | 27 | 224 | |
| 1JT9-16-12SP | 1.5/16" X12UN | R3/4" X14 | 46 | 45.2 | 33 | 300 | 20.5 |
| 1JT9-16SP | 1.5/16" X12UN | R1" X11 | 46 | 50 | 33 | 377 | 10.5 |
| 1JT9-20-16SP | 1.5/8" X12UN | R1" X11 | 52.3 | 59.7 | 41 | 531 | |
| 1JT9-20SP | 1.5/8" X12UN | R1.1/4" X11 | 52.3 | 60.5 | 41 | 660 | |
| 1JT9-24SP | 1.7/8" X12UN | R1.1/2" X11 | 59.2 | 67.1 | 48 | 878 | |

1JFL

美制JIC外螺纹74°外锥/轻系列法兰ISO 6162-1
JIC MALE 74° CONE/L-SERIES FLANGE ISO 6162-1

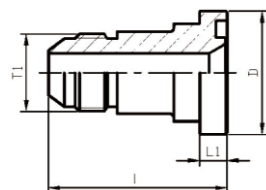

| 产品代号 PART NO. | 螺纹 THREAD | 法兰型号 FLANGESIZE | 尺寸 DIMENSIONS | | | 重量 (g) | 压力等级 MPa |
|------------------|---------------|--------------------|---------------|------|------|-------------|-------------|
| | T1 | | L1 | D | L | | |
| 1JFL-08 | 3/4" X16UNF | 1/2" | 6.73 | 30.2 | 43.5 | 103 | 34.5 |
| 1JFL-08-12 | 3/4" X16UNF | 3/4" | 6.73 | 38.1 | 45.4 | 130 | |
| 1JFL-10-08 | 7/8" X14UNF | 1/2" | 6.73 | 30.2 | 48 | 127 | 24 |
| 1JFL-10-12 | 7/8" X14UNF | 3/4" | 6.73 | 38.1 | 48 | 150 | |
| 1JFL-12-08 | 1.1/16" X12UN | 1/2" | 6.73 | 30.2 | 49 | 167 | |
| 1JFL-12 | 1.1/16" X12UN | 3/4" | 6.73 | 38.1 | 50.5 | 196 | |
| 1JFL-12-16 | 1.1/16" X12UN | 1" | 8 | 44.4 | 52.2 | 234 | |
| 1JFL-16-12 | 1.5/16" X12UN | 3/4" | 6.73 | 38.1 | 52 | 254 | |
| 1JFL-16 | 1.5/16" X12UN | 1" | 8 | 44.4 | 53.4 | 290 | 20 |
| 1JFL-16-20 | 1.5/16" X12UN | 1.1/4" | 8 | 50.8 | 52.2 | 316 | |
| 1JFL-20-16 | 1.5/8" X12UN | 1" | 8 | 44.4 | 54.5 | 376 | |
| 1JFL-20 | 1.5/8" X12UN | 1.1/4" | 8 | 50.8 | 53.1 | 398 | 17 |
| 1JFL-20-24 | 1.5/8" X12UN | 1.1/2" | 8 | 60.3 | 56 | 472 | |
| 1JFL-24-20 | 1.7/8" X12UN | 1.1/4" | 8 | 50.8 | 56.5 | 471 | 14 |
| 1JFL-24 | 1.7/8" X12UN | 1.1/2" | 8 | 60.3 | 59.2 | 547 | |
| 1JFL-24-32 | 1.7/8" X12UN | 2" | 9.53 | 71.4 | 60 | 657 | |
| 1JFL-32 | 2.1/2" X12UN | 2" | 9.53 | 71.4 | 66.3 | 1002 | |

1JFL9

90°弯美制JIC外螺纹74°外锥/轻系列法兰ISO 6162-1
90°ELBOW JIC MALE 74° CONE/L-SERIES FLANGE ISO 6162-1

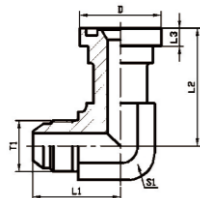

| 产品代号 PART NO. | 螺纹 THREAD | 法兰型号 FLANGESIZE | 尺寸 DIMENSIONS | | | | | 重量 (g) | 压力等级 MPa |
|------------------|---------------|--------------------|---------------|------|------|------|----|----------|-------------|
| | T1 | | L1 | L2 | L3 | D | S1 | | |
| 1JFL9-08 | 3/4" X16UNF | 1/2" | 32.5 | 44 | 6.73 | 30.2 | 22 | 167 | 31 |
| 1JFL9-08-12 | 3/4" X16UNF | 3/4" | 38 | 54.1 | 6.73 | 38.1 | 30 | 279 | |
| 1JFL9-10-08 | 7/8" X14UNF | 1/2" | 37.5 | 44 | 6.73 | 30.2 | 24 | 182 | 24 |
| 1JFL9-10-12 | 7/8" X14UNF | 3/4" | 41 | 54.1 | 6.73 | 38.1 | 30 | 292 | |
| 1JFL9-12 | 1.1/16" X12UN | 3/4" | 44.5 | 54.1 | 6.73 | 38.1 | 30 | 322 | |
| 1JFL9-12-16 | 1.1/16" X12UN | 1" | 48 | 60.2 | 8 | 44.4 | 36 | 410 | |
| 1JFL9-16 | 1.5/16" X12UN | 1" | 49 | 60.2 | 8 | 44.4 | 33 | 450 | 21 |
| 1JFL9-16-12 | 1.5/16" X12UN | 3/4" | 49 | 58 | 6.73 | 38.1 | 30 | 421 | |
| 1JFL9-16-20 | 1.5/16" X12UN | 1.1/4" | 54 | 66.5 | 8 | 50.8 | 41 | 597 | 20 |
| 1JFL9-20 | 1.5/8" X12UN | 1.1/4" | 55.5 | 66.5 | 8 | 50.8 | 41 | 666 | 17 |
| 1JFL9-20-16 | 1.5/8" X12UN | 1" | 55.5 | 65 | 8 | 44.4 | 36 | 558 | |
| 1JFL9-20-24 | 1.5/8" X12UN | 1.1/2" | 60 | 79.3 | 8 | 60.3 | 50 | 955 | |
| 1JFL9-24 | 1.7/8" X12UN | 1.1/2" | 62.5 | 79.3 | 8 | 60.3 | 50 | 1015 | 14 |
| 1JFL9-24-20 | 1.7/8" X12UN | 1.1/4" | 62.5 | 75.5 | 8 | 50.8 | 41 | 805 | |
| 1JFL9-24-32 | 1.7/8" X12UN | 2" | 74.5 | 108 | 9.53 | 71.4 | 60 | 1675 | |
| 1JFL9-32 | 2.1/2" X12UN | 2" | 80 | 108 | 9.53 | 71.4 | 60 | 1978 | |